

Monorail Trolley

5 TON CAPACITY

PRODUCT INFORMATION

DWG. NO:

NOR4013-1423

DATE: 11/10/2016

REVISION: 0

TYPE: 23

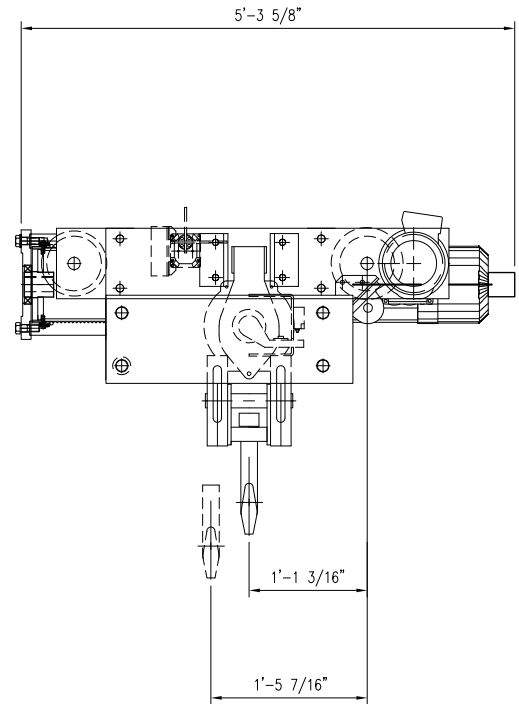
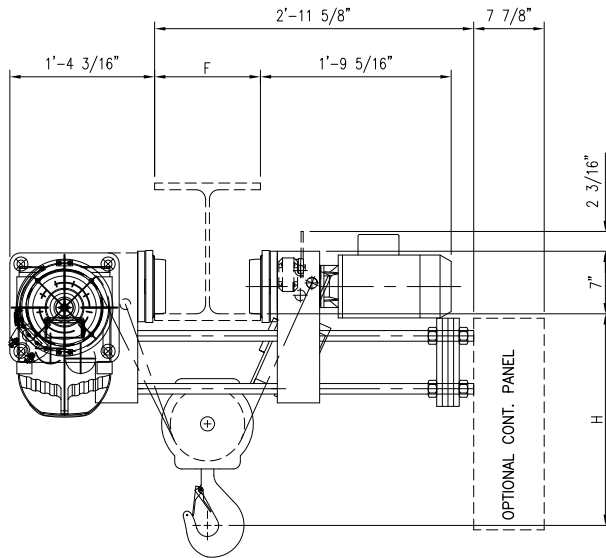

WIRE ROPE 5/16" DIA. 6 x 36 SKZ8

ACECO RESERVES THE RIGHT TO MAKE CHANGES WITHOUT NOTICE.

HOIST TECHNICAL DATA

CAPACITY	5 Tons (10,000 lbs.)	TROLLEY SPEED	MOTOR DATA	Optional: Hoisting Speed, Trolley Speed, Lift, Power Supply, etc.; Consult Factory. DRUM DIA. 7.638"
CLASS	CMAA CLASS "D"	60 FPM	.5 HP / 3600 RPM	
POWER SUPPLY	460V-3PH-60HZ			

DIMENSIONAL INFORMATION

HOIST MOTOR	HOISTING SPEED	LIFT	WEIGHT
HP/RPM	FPM	FEET	LBS.
6 HP / 3600 / 600 RPM	18 / 3 FPM	23	1,500

FLANGE WIDTH "F"	HEADROOM "H"
INCHES	
<7.87	21
<12.00	21
<15.98	OPTION
<19.68	OPTION
<23.62	OPTION