

Monorail Trolley

5 TON CAPACITY

PRODUCT INFORMATION

DWG. NO:

NOR411-5423

DATE: 08/10/2016

REVISION: 0

TYPE: 23

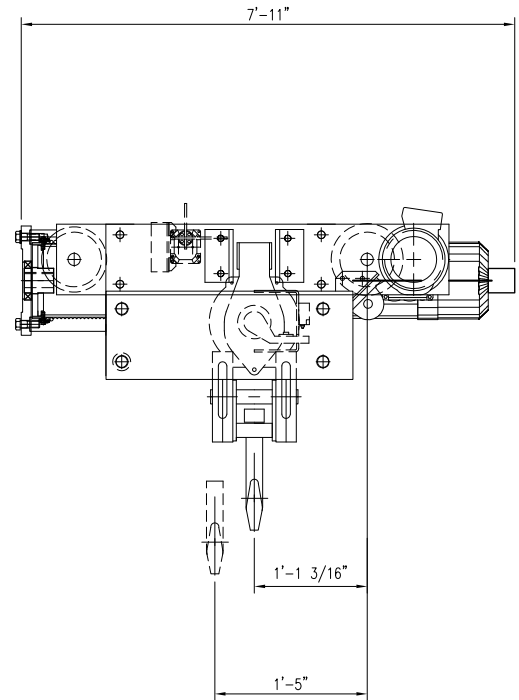
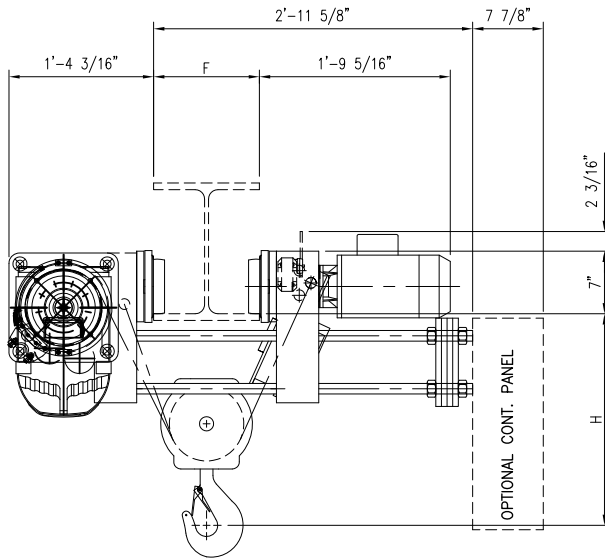

WIRE ROPE 3/8" 6 x 36 IWRC EIP

ACECO RESERVES THE RIGHT TO MAKE CHANGES WITHOUT NOTICE.

HOIST TECHNICAL DATA

CAPACITY	5 Tons (10,000 lbs.)	TROLLEY SPEED	MOTOR DATA	Optional: Hoisting Speed, Trolley Speed, Lift, Power Supply, etc.; consult factory. DRUM DIA. 8.622"
CLASS	CMAA CLASS "D"	60 F.P.M.	.5 HP / 1800 RPM	
POWER SUPPLY	460V-3PH-60HZ			

DIMENSIONAL INFORMATION

HOIST MOTOR	HOISTING SPEED	HOISTING SPEED	LIFT	WEIGHT
HP/RPM	FPM	FPM	FEET	LBS.
6 / 1800	16	24	69	1,700

FLANGE WIDTH "F"	HEADROOM "H"
INCHES	
<7.87	19
<12.00	23
<15.98	27
<19.68	31
<23.62	35