

Installation, Operation & Service Manual

For more information contact:
American Crane & Equipment Corp.
Authorized Distributor
Tel: 877-503-2972
Fax: 484-945-0430
sales@americancrane.com
www.americancrane.com

PULSE™

Monitor

Pulse™ Monitor Software Version 1.0.1
Pulse™ Monitor Card Software Revision 1.4.0
Pulse™ Monitor Card Product Revision 0.1.0.0

Table of Contents

Introduction	3
--------------------	---

Installation

Pulse Monitor Kits	4 - 5
Software Installation	5
Initial Programming	5
Tools Required For Installation	6
Mounting Pulse Monitor Card	6
Wiring	7

Operation

Specifications	8 - 9
Downloading Motor Data	10 - 11
Software Functions	11
Cumulative Data	11
Monitor Version	12
Assigning Serial Number	12
Setting Time and Date	13
Setting Voltage	13
Reading Data	14
Voltage Graph	14
Data Filters	15
Viewing Data Type (Current vs. History)	15
Changing Order of Data Grid	16
Saving and Printing Motor Data	16

Service

Troubleshooting Chart	17
Appendix 1 – Wiring Diagrams	18 - 22
Appendix 2 – Voltage Measurement Accuracy	23
Replacement Parts	23
Customer Service	23

Introduction

Congratulations on the purchase of a Pulse monitor. The Pulse monitor is an electronic device that records key information with a time/date stamp every time an AC motor is turned on. The program data can be used as a tool to help assist you in trouble shooting hard to figure out field problems for machinery-using AC motors and help determine preventative maintenance intervals.

IMPORTANT! PLEASE READ!

Before proceeding any further, please read the following important information regarding the Pulse monitor and its proper handling and use:



- The Pulse monitor is powered up by AC control voltage, which can cause electric shock resulting in personal injury or loss of life. Handle the monitor card with the same care and caution as all other high voltage electrical components.



- Be certain the electrical power supply is OFF and locked in the open position before attempting any electrical connections to the hoist.



- Be sure to disconnect all AC input power before downloading information from or handling the Pulse monitor circuit board.



- Please read this manual completely before installing the Pulse monitor.



- The Pulse monitor card must be rigidly secured in the control panel as illustrated in this manual. Failure to do so may result in damage to the Pulse monitor card and to the equipment being monitored.



- Only qualified personnel should perform service.

Pulse Monitor Kits

The Pulse monitor is available in several different kit varieties to accommodate individual needs.

Note: Shaw-Box World Series and Yale Global King hoists, which include the Pulse monitor card as standard, require a computer interface kit (sold separately) to read the data. Kit variations are as follows:

Pulse Monitor Complete Kit - Catalog Numbers

PCOMLETEKIT1 = 115 VAC Control

PCOMLETEKIT2 = 24 VAC Control

Description	Quantity
Pulse Monitor Card	1
Card Mounting Bracket	1
Pulse Monitor Computer Interface (9V battery not included)	1
Serial Extension Cable (6 ft.)	2
Pulse Monitor Software Disk	1
Pan Head Phillips Screw Self Tap #6-32 X 5/8"	6 (2 extra)
Pan Head Phillips Screw Self Tap #10-24 X 1/4"	3 (1 extra)
Terminal Wire Insulated Female Quick Connector	
Panduit Part no. DNR14-188F1B-C (tab size 0.187 X 0.020)	10 (3 extra)
16# Insulated Wire	15 ft.

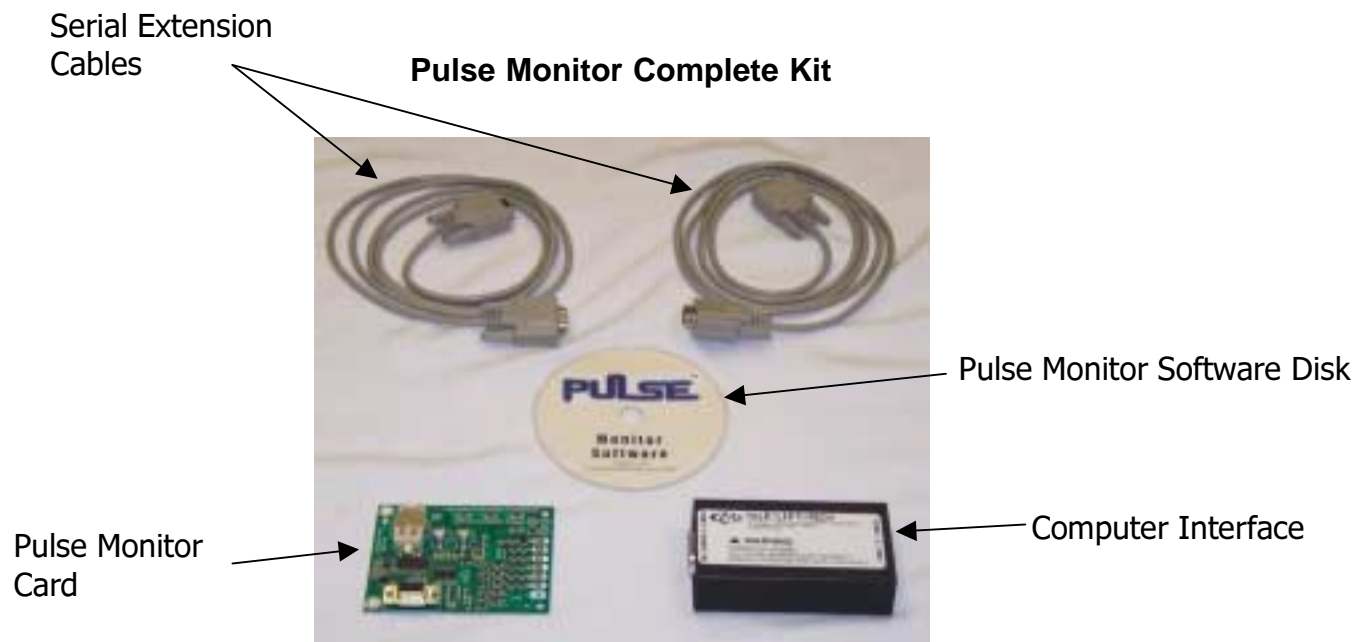

Pulse Monitor Computer Interface Kit – Catalog No. PINTERFACEKIT

Description	Quantity
Pulse Monitor Computer Interface (9V battery not included)	1
Serial Extension Cable (6 ft.)	2
Pulse Monitor Software Disk	1

Pulse Monitor Kits (cont.)

Pulse Monitor Individual Card Kit - Catalog Numbers

PCARDKIT1 = 115 VAC Control

PCARDKIT2 = 24 VAC Control

<u>Description</u>	<u>Quantity</u>
Pulse Monitor Card	1
Card Mounting Bracket	1
Pulse Monitor Software Disk	1
Pan Head Phillips Screw Self Tap #6-32 X 5/8"	6 (2 extra)
Pan Head Phillips Screw Self Tap #10-24 X 1/4"	3 (1 extra)
Terminal Wire Insulated Female Quick Connector	
Panduit Part no. DNR14-188F1B-C (tab size 0.187 X 0.020)	10 (3 extra)
16# Insulated Wire	15 ft.

Software Installation

Insert the Pulse software disk into your CDROM drive. Using the **RUN** command in your start menu button, browse to your CDROM drive. Open folder 1.0.1. Double click on the **Install Pulse** file. Select **OK** and follow instructions. During the install, say yes to installing the Microsoft.net framework program if prompted. This is necessary for the Pulse software to operate. Observe minimum system requirements: **Operating System** - Windows XP Pro SP2, or Windows 2000 SP4. **CPU** - Pentium III, 450 MHz, **RAM** - 256 MB. **Hard Drive Space** - 50MB. **One Serial Port. CDROM Drive.**

Initial Programming

Initial programming can be done before or after the Pulse monitor card is installed. Open the Pulse software on your computer and connect the Pulse monitor card as shown in Figure 3. It is recommended that the following parameters be set before collecting any data.

Serial Number - In the *Serial Number Box*, enter the serial number for the system you wish to monitor. Click on the **Set** button to program the serial number.

Monitor Date - In the *Monitor Date Box*, click on the **Set** button to set the monitor card clock to your computers clock. Note: If this is not done, the default time for the monitor card is midnight, January 1, 1970.

Voltage - In the *Voltage Box*, enter the source voltage the motor is being powered by. Click on the **Set** button to program the source voltage.

For further information concerning these parameters, see the **Software Functions** section of this manual.

Tools Required For Installation

- ✓ Drill & #19 Drill Bit (ϕ .166")
- ✓ #1 Phillips Screw Driver
- ✓ Wire Strippers
- ✓ Connector Crimping Tool (Sized for 16# wire)

Mounting Pulse Monitor Card

- 1) Locate available space in control enclosure to fit the required 3" X 5-1/4" X 2-1/2" envelope. Use a #19 drill bit (ϕ .166") and drill two holes 4.75" +/- .02" apart. Attach the mounting bracket using (2) #10-24 X 1/4" self-tapping screws at reference points **A**. See Figure 1.
- 2) Attach Pulse monitor card to mounting bracket using (4) #6-32 X 5/8" self-tapping screws at reference points **B**. See Figure 1.

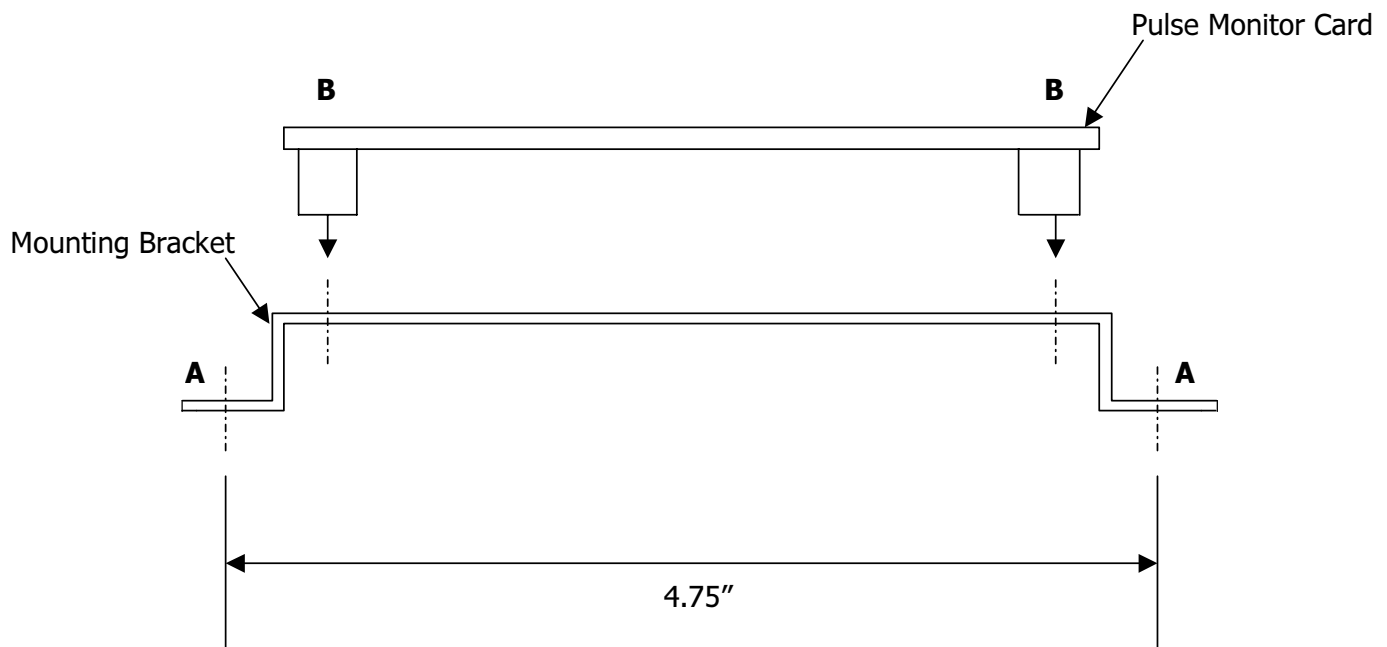
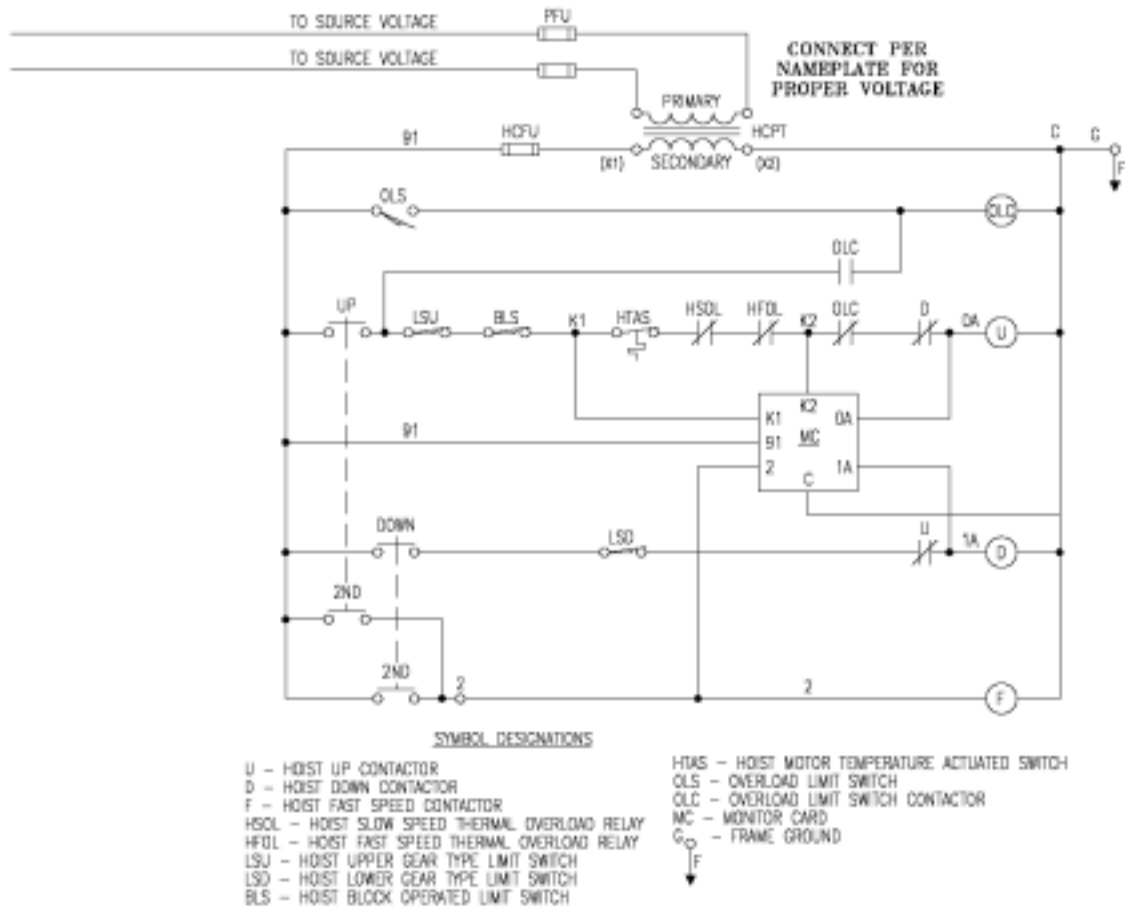

Figure 1

Wiring

- 1) Review electrical schematic. See Figure 2.
- 2) See Appendix 1 for detailed wiring diagrams specific to selected Yale-Lift-Tech arrangements.



- ORDER OF LIMIT SWITCHES IN THE UP CIRCUIT:
1. UP PUSHBUTTON
 2. BLOCK LIMIT, GEARED LIMIT, OVERWRAP AND SWITCHES OTHER THAN THERMAL AND OVERLOAD SWITCHES
 3. THERMAL SWITCH
 4. THERMAL OVERLOADS (IF PROVIDED)
 5. OVERLOAD SWITCH OR CONTACT
 6. UP COIL OR INPUT TO THE DRIVE

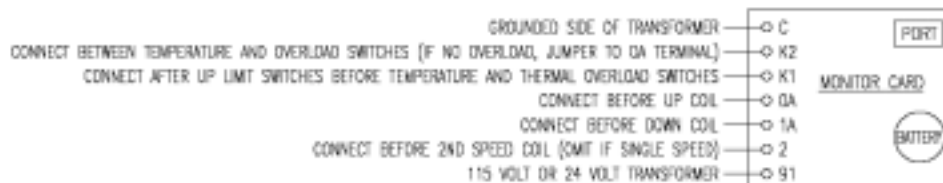

Figure 2

Warning: The Pulse monitor card is electronic equipment that requires earth ground to reduce potential for false data. If a dedicated ground is not available, make sure reference ground to all control transformers have one common point.

Specifications

The Pulse monitor records the following information:

Motor Event Parameters - Motor direction is referenced as *Up* or *Down*. The Pulse monitor can record up to two speed points. The speed points are referenced as *Slow* and *Fast*. The following are all the designated motor events that can be recorded:

Motor Event

Motor Up Slow

Motor Up Fast

Motor Down Slow

Motor Down Fast

Plug Event *Excessive Plugging*

Motor Trip Up *Thermal Shutdown*

Motor Trip Up Fast *Thermal Shutdown*

Over Capacity Up

Over Capacity Up Fast

Data Filters

(Normal Start), (Slow), (Up)

(Normal Start), (Fast), (Up)

(Normal Start), (Slow), (Down)

(Normal Start), (Fast), (Down)

(Plug Event)

(Motor Trip), (Up)

(Motor Trip), (Up)

(Over Capacity), (Up)

(Over Capacity), (Up)

Current Motor Events - The Pulse monitor records all current motor events up to a maximum of 5119 events. After 5119, each new motor event will record over the oldest motor data beginning at memory count one.

History Events - The Pulse monitor records the following motor events simultaneously into the *current* and *history* motor event memory registers. The motor events are plug event, motor trip and over capacity. The history event register can store up to 64 occurrences before recording over the oldest data located in memory count one.

Cumulative Run Time - Every time the motor is energized, the Pulse monitor records how long it runs and adds to the cumulative total run time. Maximum time count is 1.9 million hours. Cumulative run time is updated every 16 motor starts. Overall operating time cannot be reset to zero.

Cumulative Motor Starts - Pulse monitor keeps track of overall starts of a motor. Maximum start count is 4.29 billion. The cumulative memory location is updated every 16 motor starts. Overall starts cannot be reset to zero.

Motor Starts - A motor start is recognized by energization of either the slow or fast motor winding for 300ms or more.

- * Pulse monitor card revision 1.3.0 - counts a motor start when either the slow or fast winding of the motor is energized, with exception of the transition from fast to slow. No time constraints are in place for determining a motor start.

Specifications (cont.)

Plug Event (Excessive Plugging) - A plug event is recorded when the directional contactor (node 0A or 1A) is energized four times within any two second period of operation. The plug event is recorded simultaneously into current motor data and history data.

* *Pulse monitor card revision 1.3.0* - records a plug event when there are 10 motor starts within any 10-second period of operation.

Motor Trip Event - Motor Trip Event - A motor trip event will be recorded when the monitor card terminal K1 measures 115 volts* and terminal K2 is at 0 volts. If the event occurs with all three terminals K1, K2 and 0A being at 0 volts followed by numerous occurrences of terminal K1 sensing 115 volts* and K2 remaining at 0 volts, only one event will be recorded.

Over Capacity Event - An overcapacity trip will be recorded when the monitor card terminals K1 and K2 measure 115 volts* and terminal 0A being at 0 volts. If the event occurs with all three terminals K1, K2 and 0A being at 0 volts followed by numerous occurrences of terminal K1 and K2 sensing 115 volts* and 0A remaining at 0 Volts, only one event will be recorded.

Voltage - For every motor event, the voltage will be measured.**

Time / Date Stamp - All motor events are recorded along with the time and date the motor event occurred. The real time clock in the Pulse monitor card has a default starting time of midnight, January 1, 1970. Once the Pulse monitor software connects to the card, you can change the default time to your computer's time by pressing the **Set** button.

* All cited voltages are nominal referenced to ground using the 115-volt monitor card. If using the 24-volt card, all non-zero voltage references will be 24 volts.

** See Appendix 2 for discussion of accuracy.

Downloading Motor Data

Motor event data stored in the Pulse monitor card can only be read using a personal computer (PC).

Connections

- 1) Connect the Pulse monitor card, computer interface, PC and serial extension cables as shown in Figure 3.

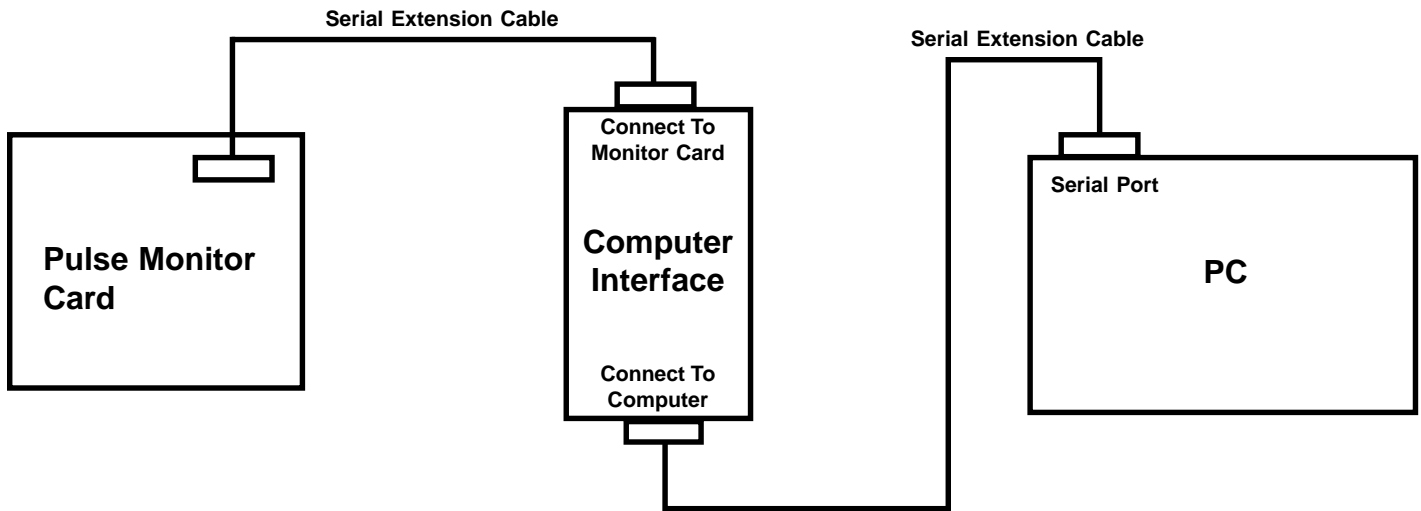

Figure 3

- 2) Open Pulse monitor software on computer and press the **Connect** button. See Figure 4

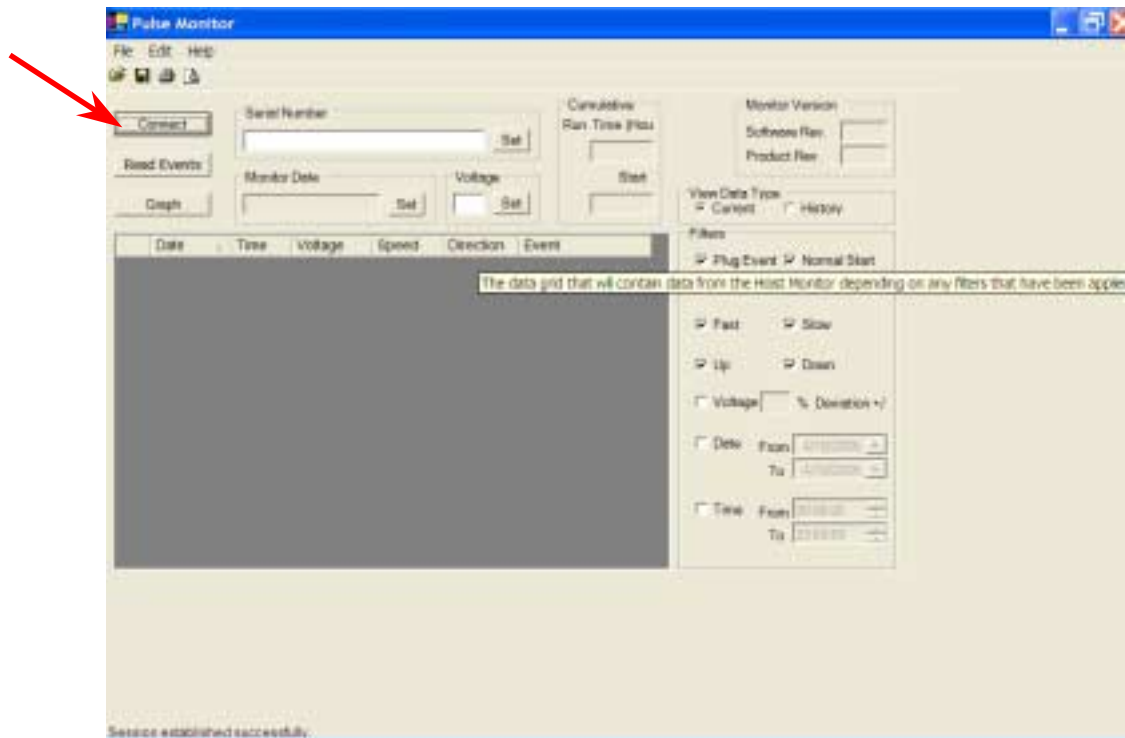

Figure 4

Downloading Motor Data (cont.)

- 3) If your connection was successful, the following message **Session established successfully** will be displayed in the lower left corner. The monitor date, monitor version and cumulative run time / start data will also appear. See Figure 5.

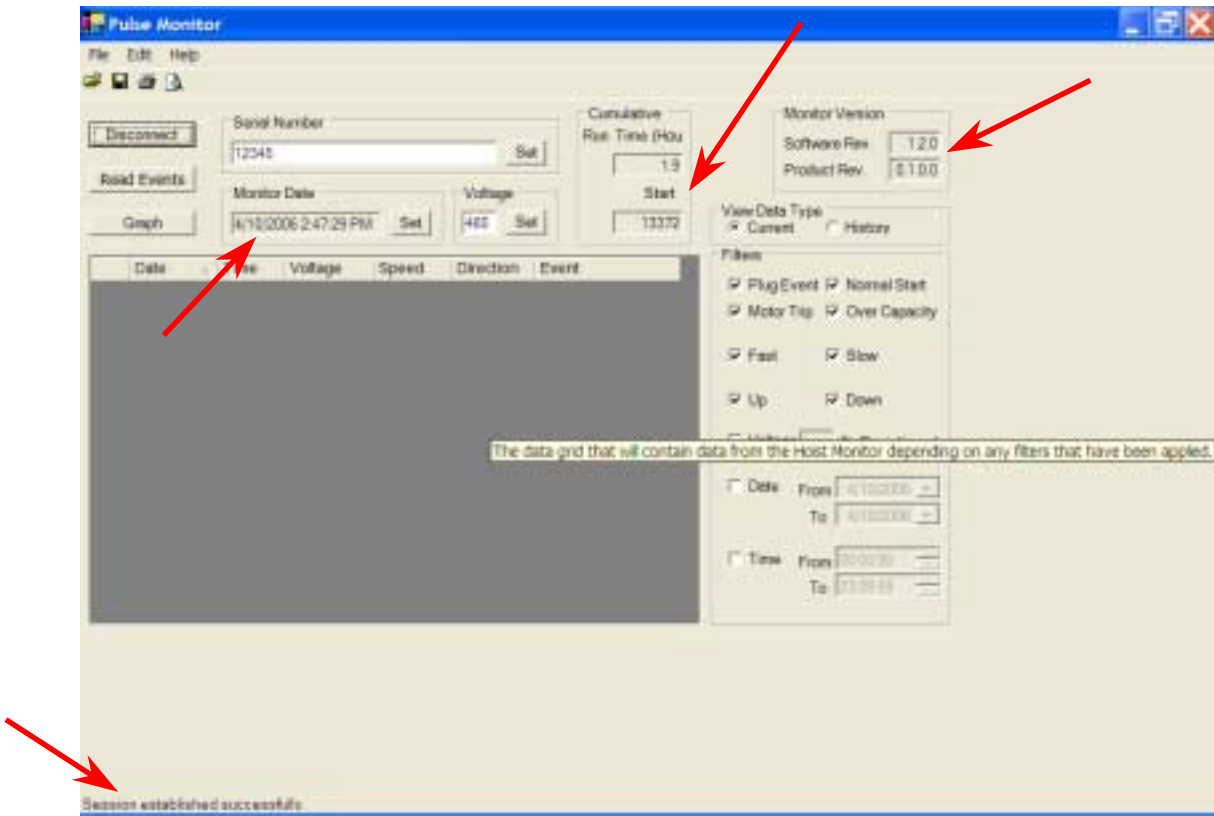

Figure 5

Software Functions

Cumulative Data

The Pulse monitor card keeps track of total motor run time and total motor starts for the motor being monitored. The displayed cumulative data is automatically updated every 16 motor starts. Note this data cannot be reset. See Figure 6.

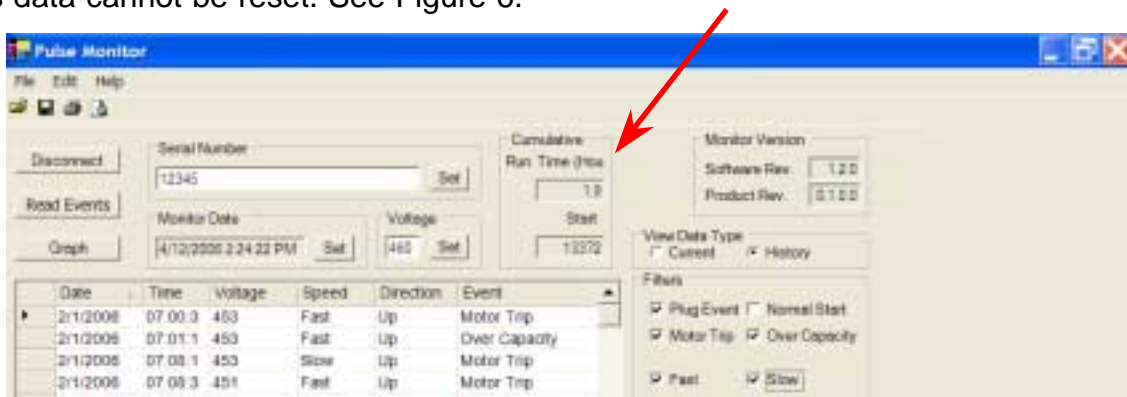

Figure 6

Software Functions (cont.)

Monitor Version

The Pulse monitor software and card revision number will automatically display once you connect to the card. See Figure 7.

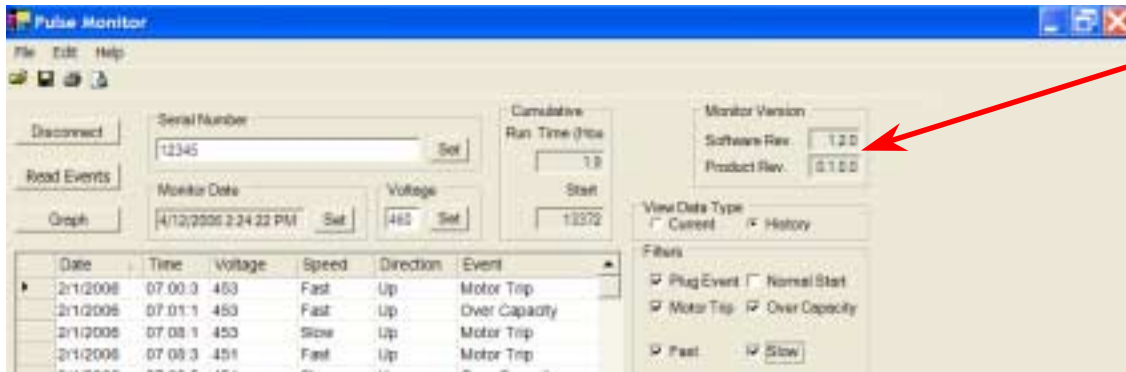

Figure 7

Assigning Serial Number

You can assign a specific serial number to the Pulse monitor card up to 20 characters for the system you wish to retrieve data from. Click on the serial number box and enter the respective serial number. Then press the **Set** button. See Figure 8.

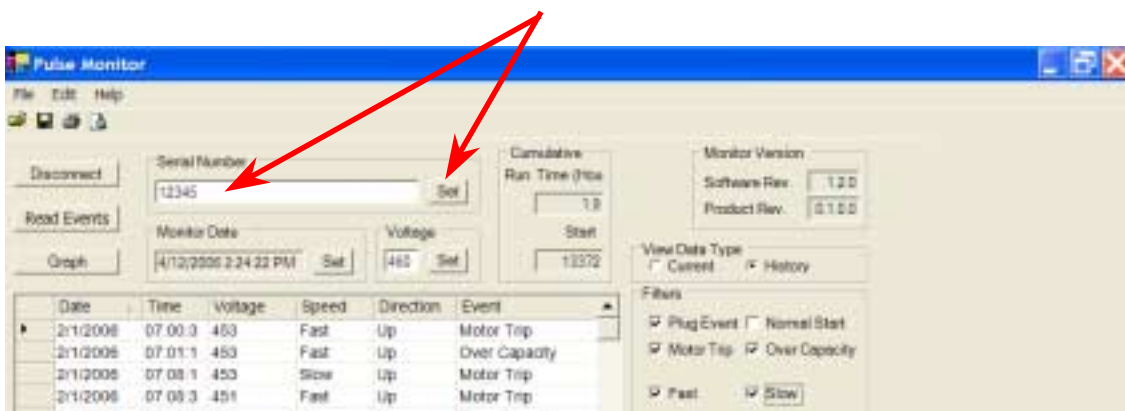

Figure 8

Software Functions (cont.)

Setting Time and Date

The time / date of all Pulse monitor cards default to midnight, January 1, 1970. By pressing the **Set** button in the *Monitor Date box*, the software will automatically update the time in the Pulse monitor card to match the computer being used. See Figure 9.

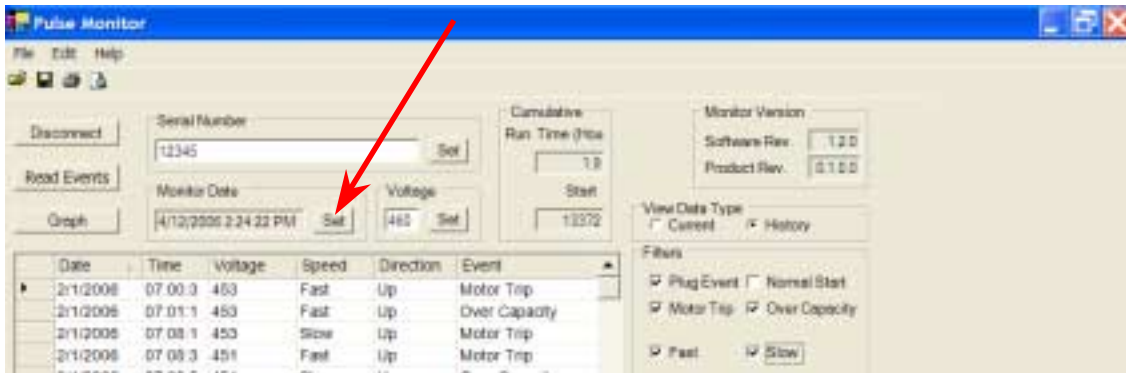

Figure 9

Setting Motor Voltage

The Pulse monitor card monitors the motor voltage of your system.* Enter the correct power supply voltage required for your system, and press the **Set** button in the *Voltage box*. See Figure 10.

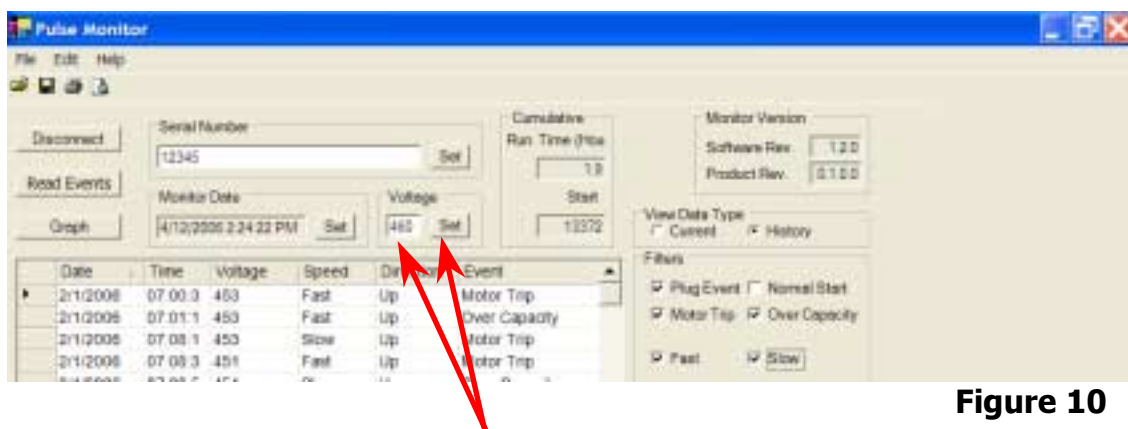

Figure 10

* See Appendix 2 for discussion of accuracy.

Software Functions (cont.)

Reading Data

Pressing the **Read Events** button as shown in Figure 11 will read all data accumulated in the Pulse monitor card.

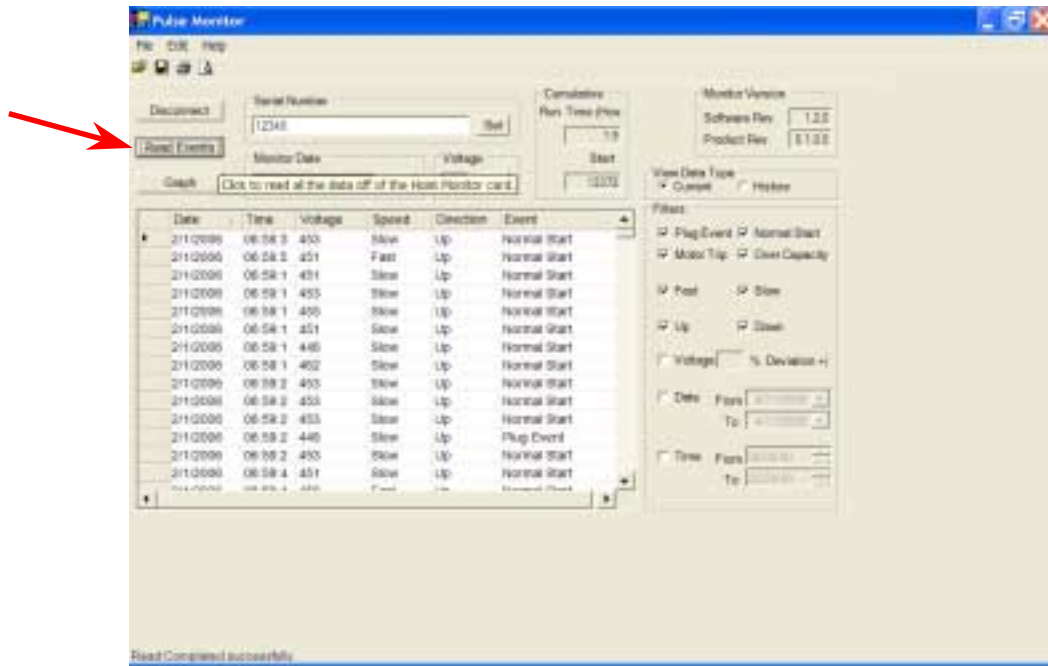

Figure 11

Voltage Graph

Press the **Graph** button to read a graph showing a broad snapshot of what the voltage was for all motor events.* See Figure 12. **Note:** To view graph at a specific date or time, select pertinent date/time in filter box.

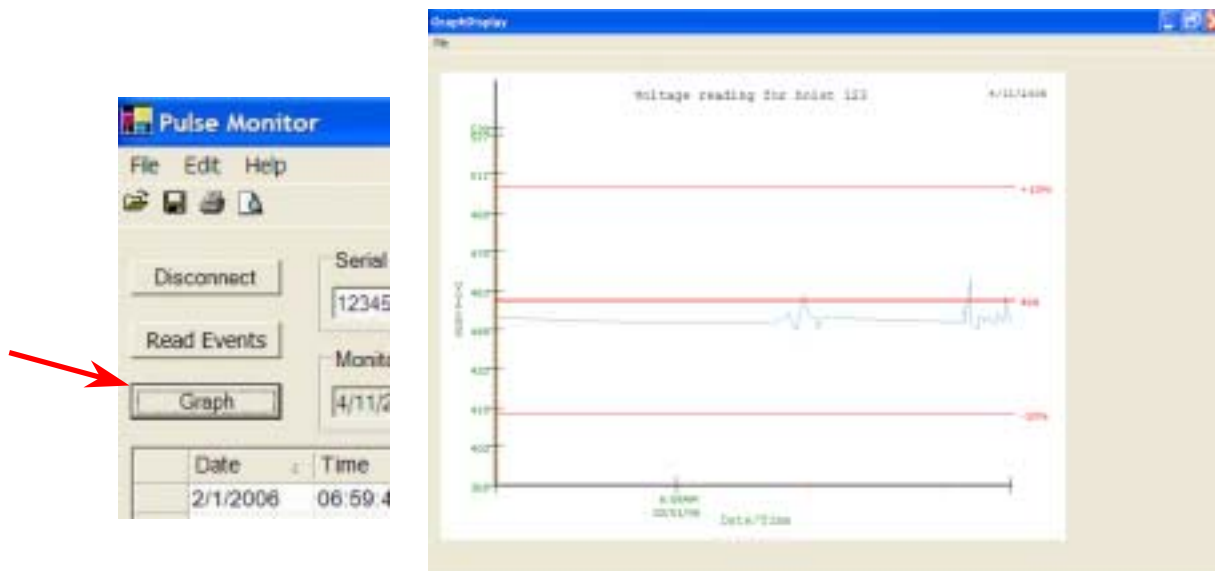

Figure 12

* See Appendix 2 for discussion of accuracy.

Software Functions (cont.)

Data Filters

Data filters allow you to narrow down the specific type of data you wish to view. The default selects all motor events for review. If there is specific data you do not wish to see, simply uncheck the respective box and that data will be removed from your data grid. The filters include the different motor event types, voltage deviation, specific date and specific time. See Figure 13.

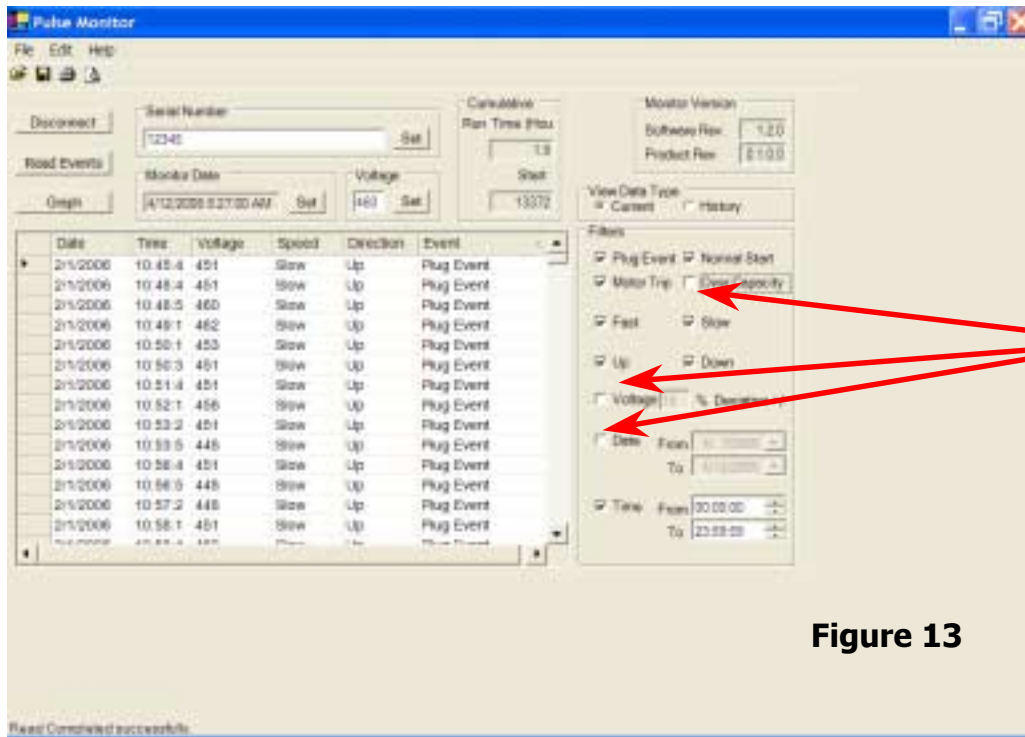

Figure 13

View Data Type (Current vs. History)

The *View Data Type* box allows you to choose between *Current* data, which is the most recent motor events up to a maximum of 5119, or *History* data. *History* data is reserved specifically for Plug Event, Motor Trip and Over Capacity events. The maximum memory count is 64 for each event type. See Figure 14.

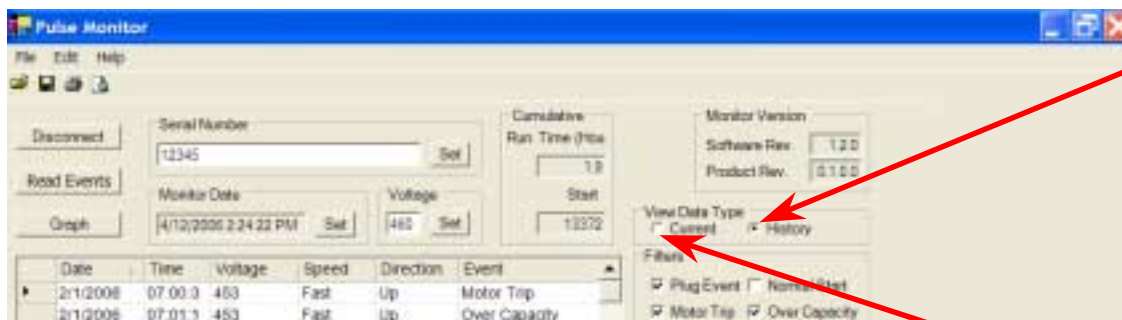

Figure 14

Software Functions (cont.)

Changing Order of Data Grid

You can also change the order in which you view the motor data by clicking on any of the column headers in the data grid. For example, the default order for date and time begins with the oldest date and time stored. If you wish to begin viewing from the most recent data to the oldest data, select the *Date* and/or *Time* headers and this will reverse the order. See Figure 15.



Figure 15

Saving and Printing Motor Data

Once you have successfully downloaded the motor data to the Pulse monitor, you can save or print the data using either the *File Menu* or *Save and Print Hot Buttons*. The file will be automatically saved as an *.xml file*. Use the Pulse monitor software any time you wish to review or print the file.

Troubleshooting Chart

Problem	Solutions
<p>Prompted Message: Pulse monitor could not be read. Check cable connections and/or 9V battery located in the computer interface before attempting to reconnect.</p>	<ol style="list-style-type: none"> 1. Check to make sure the serial connections are secure. 2. Make sure the computer interface has a 9V battery installed and that the battery is good. 3. Make sure printed circuit board in the computer interface was not inadvertently switched around when the 9V battery was installed. Labeled connectors on printed circuit board must match interface labeling. I.e: Connect to Computer or Connect to monitor card 4. Replace 9-wire serial cables. If the problem still exists, replace the computer interface.
<p>Prompted Message: This card is blank, no records have been written to it yet; data displayed is not accurate.</p>	<p>If the card is new, upon connection you will get this message. Once the Pulse monitor card begins accumulating data, the message will disappear.</p>
<p>False motor trips. Example: Thermal trip in down direction for hoist motion.</p>	<p>Check K1 or K2 input of Pulse card for floating voltage. Example: If motor is moving in down direction, K1 and K2 should read 0 V. If K1 or K2 reads other than 0 V, check all control transformers to verify they have a common ground. Provide common ground as necessary.</p>
<p>Event column of the data grid is blank.</p>	<p>When the storage of events has reached memory capacity, a blank event is produced to signify the overwriting of older events. A blank event will occur in both the current and history data. Disregard as an actual event.</p>
<p>Event has been recorded with a 1971 date stamp after the date/time has been set on the card.</p>	<p>The date indicates that as power was applied to terminal 91 on the monitor card, voltage was already present on either terminal K1,K2,0A or 1A, then removed within 1 second of power being applied to terminal 91. In the first second of turning on power, avoid applying a run command.</p>
<p>Motor Starts field equals 4294967295 and the Run Time (Hours) field equals 1193046.5</p>	<p>The card has not accumulated a total of 16 motor starts which is required for the Motor Starts and Run Time fields to update. Accumulate a minimum of 16 motor starts before attempting to read card data.</p>

Appendix 1

Wiring Diagrams

2-Speed Global Series 3, 700 or 800 Series hoist with geared limit switch, motor thermal switch, thermal overload relays and overcapacity limit switch.

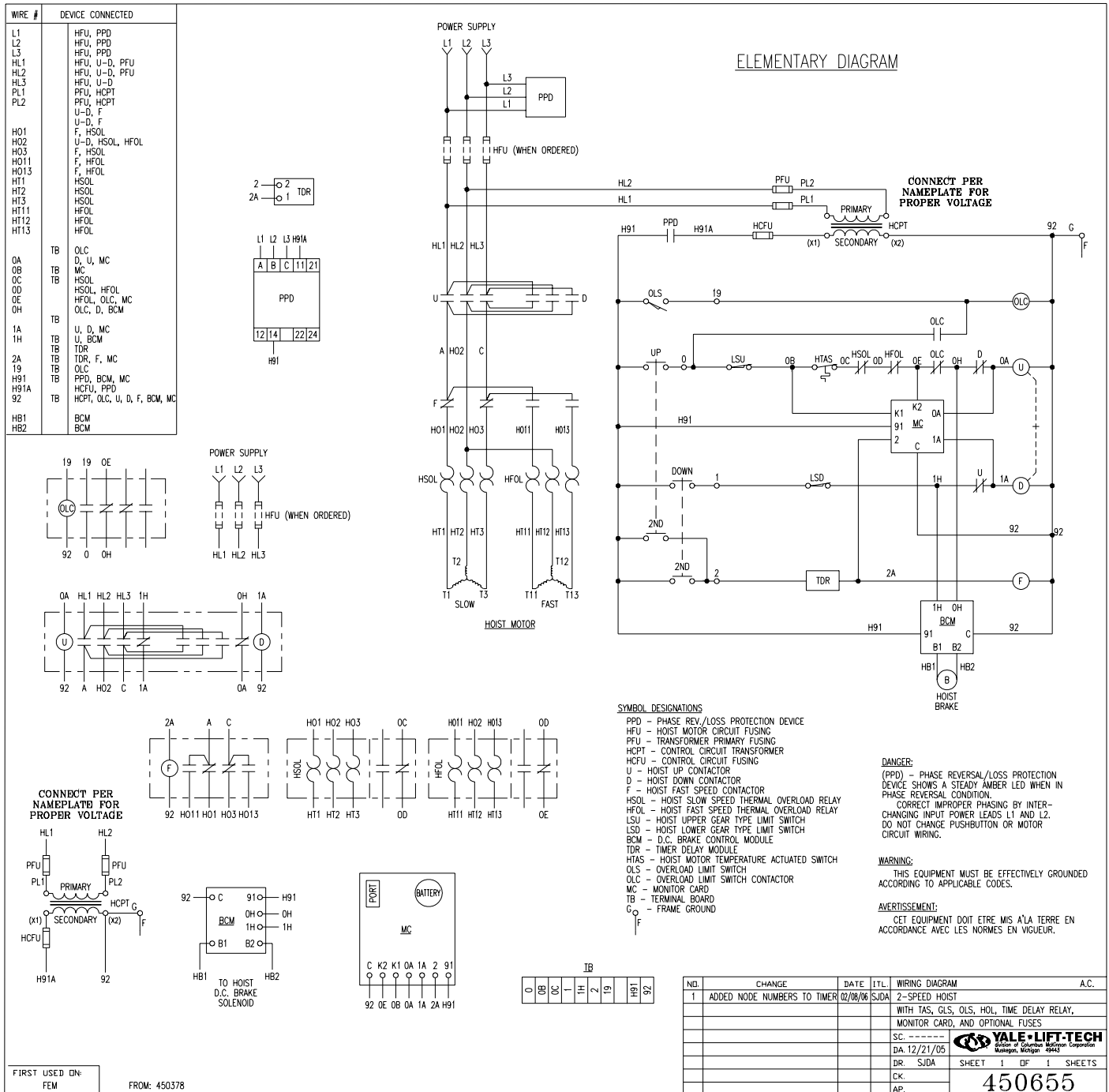

Appendix 1 (cont.)

Wiring Diagrams

2-Speed 700 or 800 Series hoist with geared limit switch, block limit switch and motor thermal switch.

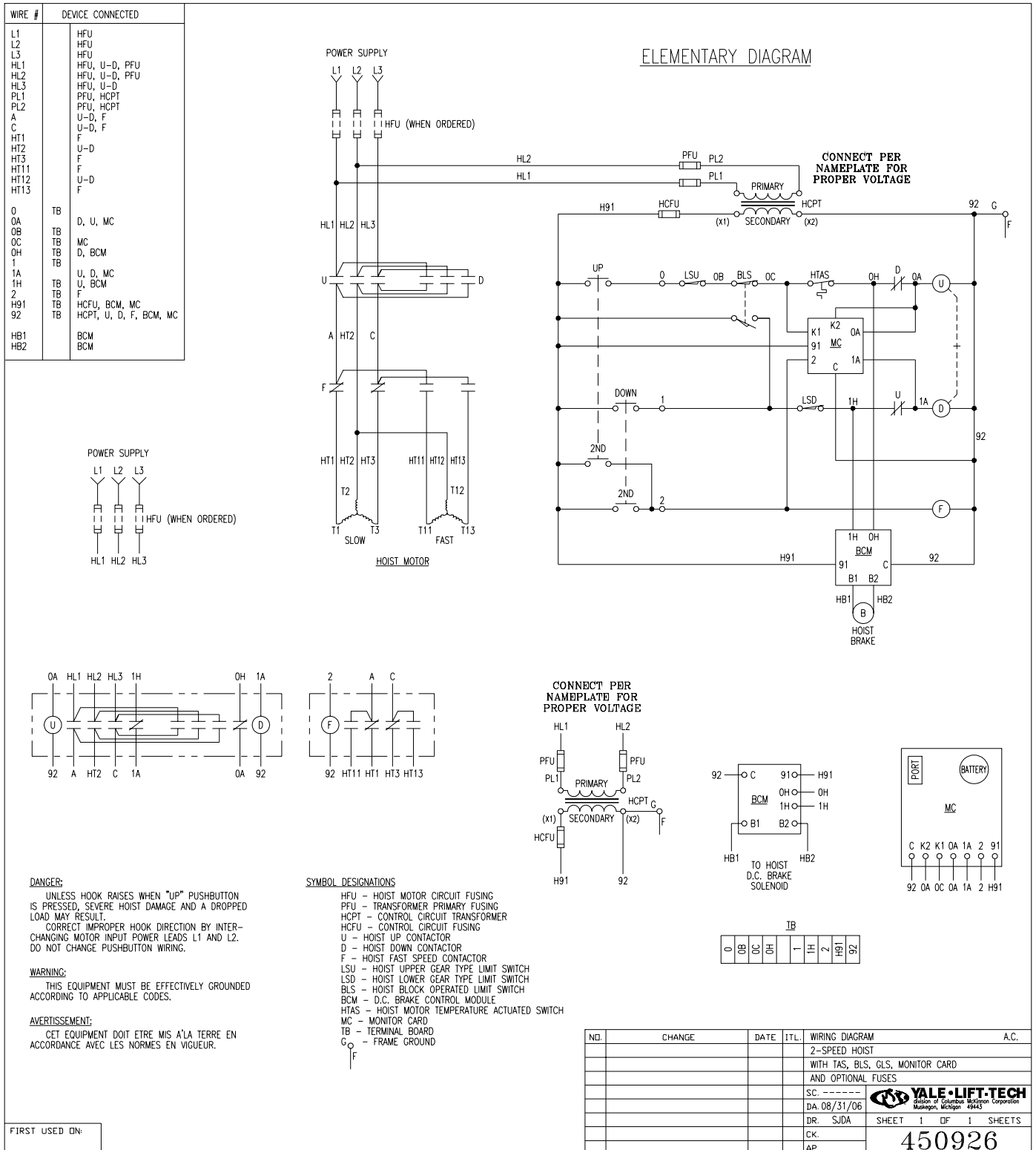

Appendix 1 (cont.)

Wiring Diagrams

1-Speed Cable King with geared limit switch, block limit switch, motor thermal switch and overcapacity limit switch.

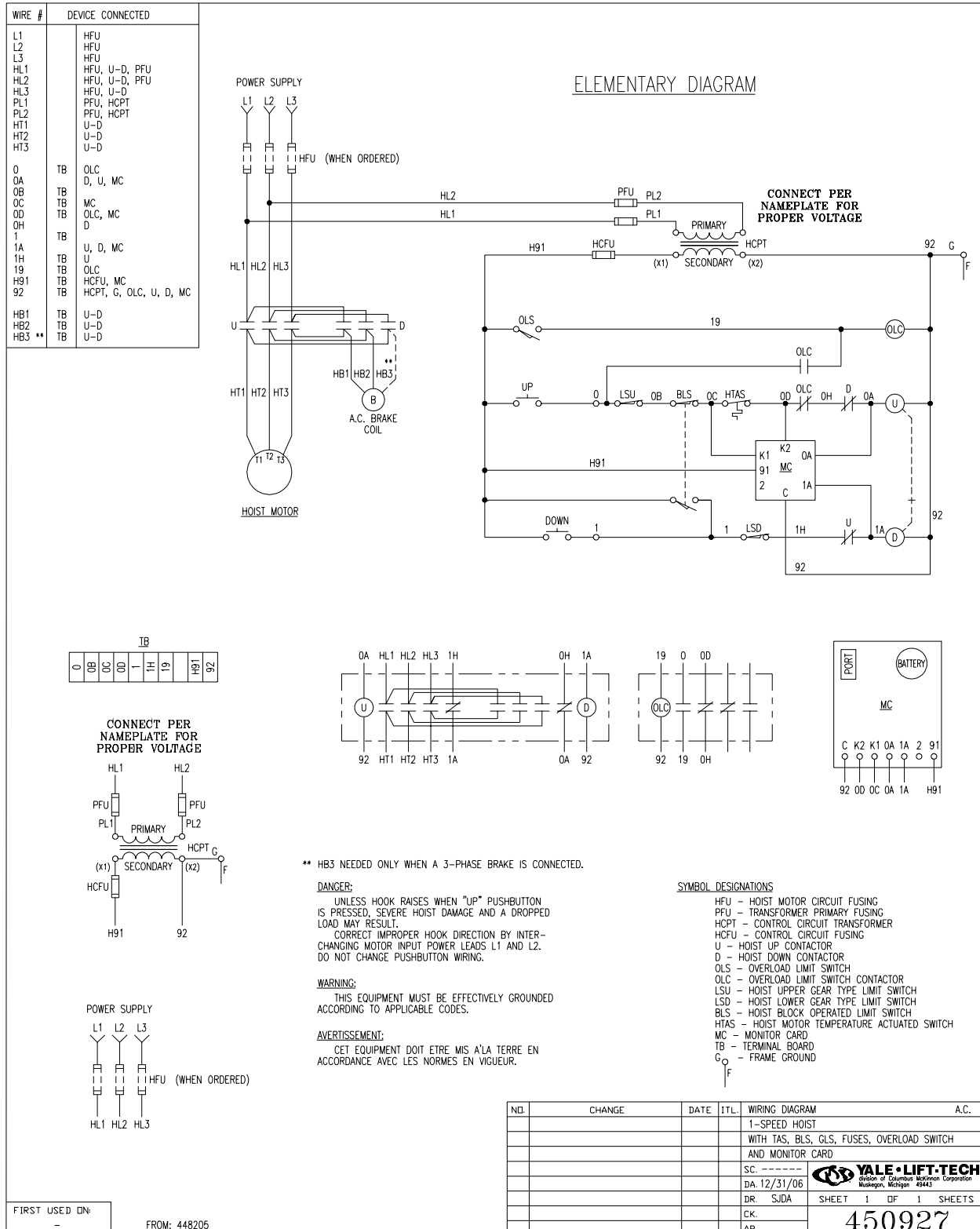

Appendix 1 (cont.)

Wiring Diagrams

2-Speed trolley with motor thermal switch.

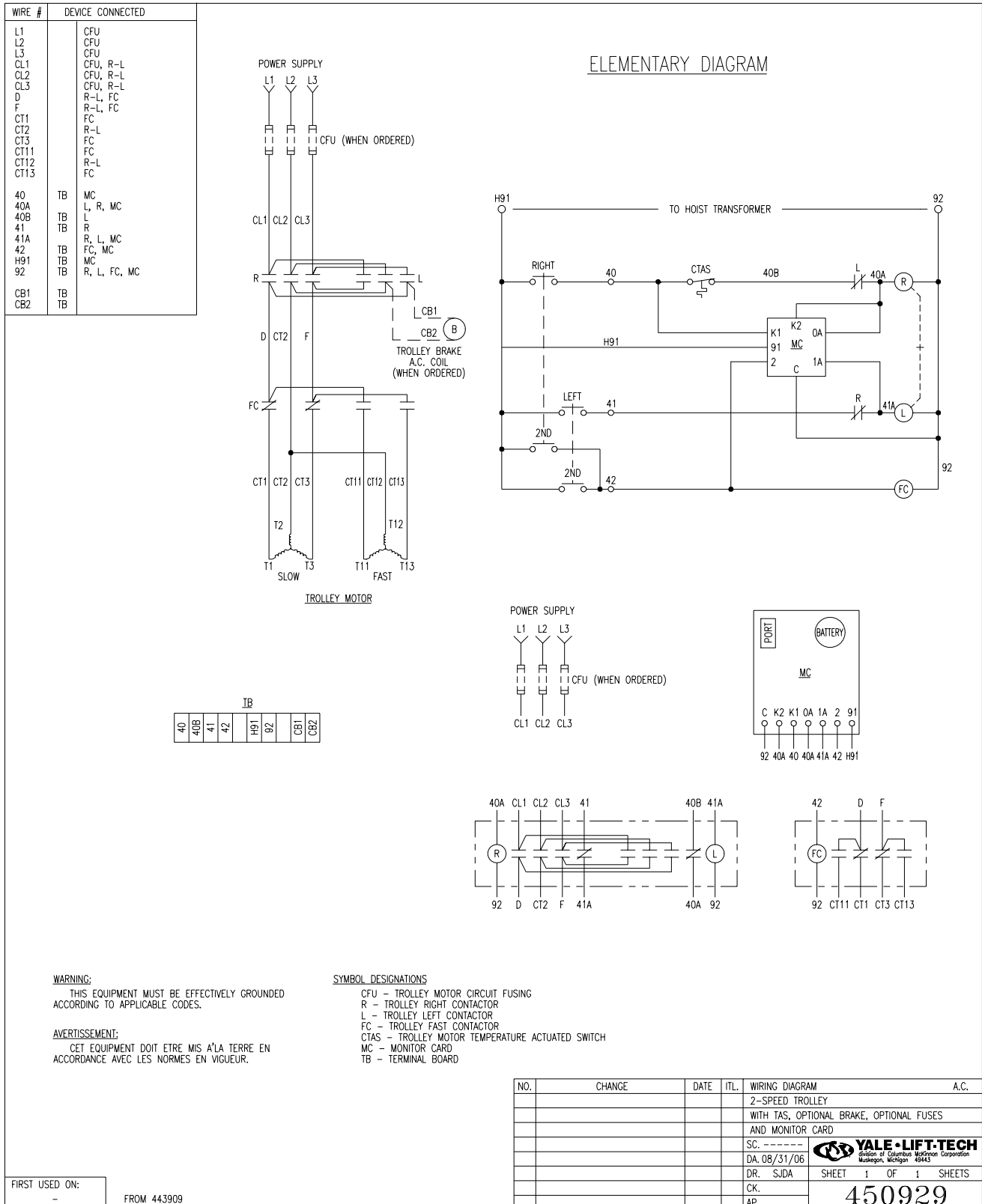

Appendix 2

Voltage Measurement Accuracy

While the Pulse monitor itself is capable of +/-5% voltage measurement accuracy, two additional factors may further decrease accuracy. Motor voltage is calculated using the control voltage powering the Pulse monitor. This calculation is based on the ideal ratio of the control transformer (primary voltage to secondary voltage). Any variation in the control transformer ratio will consistently skew the motor voltage data. Additionally, this voltage measurement is made at the point where the Pulse monitor is connected. If this point is significantly removed from the motor being monitored, a noticeable voltage drop may exist. The user is cautioned to consider both these contributing factors while interpreting the stored voltage data.

Replacement Parts

<u>Description</u>	<u>Part Number</u>
Serial Extension Cable	23386403

Customer Service

For Customer Service, please call 1 800 742-9269. Note: Customer support is available for Pulse monitor kits used in any unmodified Yale-Lift-Tech equipment.

WARRANTY

WARRANTY AND LIMITATION OF REMEDY AND LIABILITY

A. Seller warrants that each new Pulse Monitor Kit (excluding software, documentation and similar items), when shipped, will be free from defects in material and workmanship. All claims for defective products or parts under this warranty must be made in writing immediately upon discovery and, in any event, within sixty (60) days from shipment. Defective items must be held for Seller's inspection and returned to the original f.o.b. point upon request. This warranty shall not extend to labor required to repair goods or replace defective parts, or related shipping costs. THE FOREGOING IS EXPRESSLY IN LIEU OF ALL OTHER WARRANTIES WHATSOEVER, EXPRESS, IMPLIED AND STATUTORY, INCLUDING, WITHOUT LIMITATION, THE IMPLIED WARRANTIES OF MERCHANTABILITY AND FITNESS.

B. Upon Buyer's submission of a claim as provided above and its substantiation, Seller shall at its option either (i) repair or replace its product or part at either the original f.o.b. point of delivery or at Seller's authorized service station nearest Buyer; or (ii) refund an equitable portion of the purchase price.

C. This warranty is contingent upon Buyer's proper maintenance and care of Seller's product. Seller reserves the right to void warranty in event of Buyer's use of inappropriate materials in the course of repair or maintenance, or if Seller's products have been dismantled prior to submission to Seller for warranty inspection.

D. THE FOREGOING IS SELLER'S ONLY OBLIGATION AND BUYER'S EXCLUSIVE REMEDY FOR BREACH OF WARRANTY, AND IS BUYER'S EXCLUSIVE REMEDY HEREUNDER BY WAY OF BREACH OF CONTRACT, TORT, STRICT LIABILITY OR OTHERWISE. IN NO EVENT SHALL BUYER BE ENTITLED TO OR SELLER LIABLE FOR INCIDENTAL OR CONSEQUENTIAL DAMAGES.

For more information contact:
American Crane & Equipment Corp.
Authorized Distributor
Tel: 877-503-2972
Fax: 484-945-0430
sales@americancrane.com
www.americancrane.com



YALE · LIFT-TECH
division of Columbus McKinnon Corporation

414 West Broadway Ave.
P.O. Box 769
Muskegon, Michigan 49443-0769
(800) 742-9269 Phone
(800) 742-9270 Fax