

**OPERATING,
MAINTENANCE &
PARTS MANUAL**

For more information contact:
American Crane & Equipment Corp.
Authorized Distributor
Tel: 877-503-2972
Fax: 484-945-0430
sales@americancrane.com
www.americancrane.com

**MANUALLY LEVER
OPERATED
CHAIN HOIST**

Yale® PE2 Lever Hoist

Capacities: 3/4, 1-1/2, 3 and 6
tons (750, 1500, 3000 and
6000 kg.)

**Follow all instructions and warnings for
inspecting, maintaining and operating this
hoist.**

The use of any hoist presents some risk of personal injury or property damage. That risk is greatly increased if proper instructions and warnings are not followed. Before using this hoist, each operator should become thoroughly familiar with all warnings, instructions and recommendations in this manual. **Retain this manual for future reference and use.**

Forward this manual to operator.
Failure to operate equipment as directed in
manual may cause injury.

Before installing hoist, fill in the
information below.
Model No. _____

Serial No. _____

Purchase Date _____

Rated Load _____

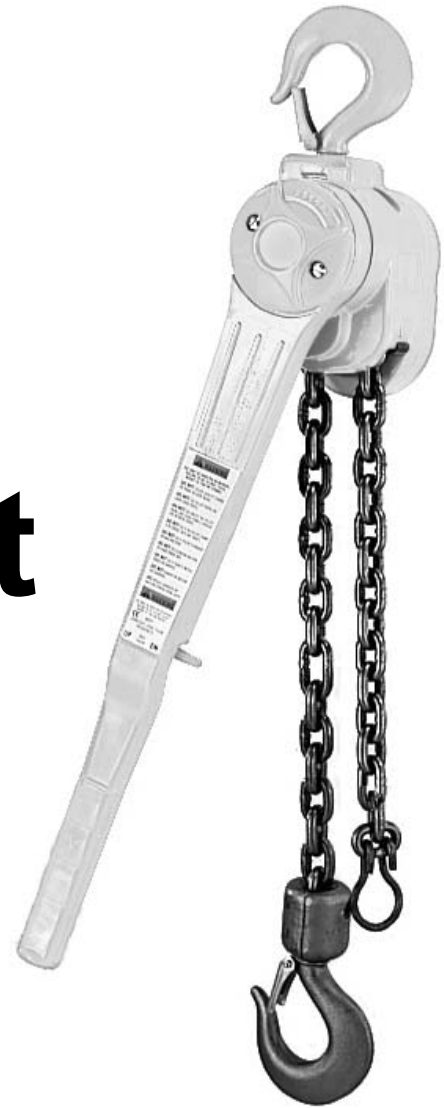

Yale® HOISTS

414 WEST BROADWAY AVENUE
MUSKEGON, MICHIGAN 49443

FOREWORD

This manual contains important information to help you properly install, operate and maintain your Yale Lever Hoist for maximum performance, economy and safety.

Please study its contents thoroughly before putting your lever hoist into operation. By practicing correct operating procedures and by carrying out the recommended preventive maintenance suggestions, you will be assured of long, dependable and safe service.

After you have completely familiarized yourself with the contents of this manual, we recommend that you carefully file it for future reference.

The information herein is directed to the proper use, care and maintenance of the Yale Lever Hoist and does not comprise a handbook on the broad subject of rigging.

Rigging can be defined as the process of lifting and moving heavy loads using hoists and other mechanical equipment. Skill acquired through specialized experience and study is essential to safe rigging operations. For rigging information, we recommend consulting a standard textbook on the subject.

A copy of this manual is packed with each Yale Lever Hoist.

TABLE OF CONTENTS

Hoist Parts Depots and Service Centers	i
Do's and Do Not's	ii
Hoist Safety Is Up To You	iii
Foreword	1
Specifications	2
Yale Repairs/Replacement Policy	2
Load Limiter.....	2
Anchor Sling.....	2
Hooks	2
Load Sentry	3
INSTALLATION AND OPERATION	
Unpacking Information	3
Installation	3
Operating Instructions	4
INSPECTION	5
Frequent Inspections.....	5
Periodic Inspections	6
Hook Inspection.....	6
Chain Inspection.....	6
Chain Lubrication	7
MAINTENANCE	
Lubrication	7
Exterior Finish	7
Preventive Maintenance.....	8
Recommended Spare Parts	8
Disassembly	8
Assembly.....	8
Reeving	9
Cutting Chains.....	15
Testing	15
Trouble Shooting	16
LOAD LIMITER	17
REPAIR PARTS	
Ordering Information.....	11
Parts List	11-12
Exploded Views.....	13-14

LIST OF ILLUSTRATIONS

	PAGE
Figure 1 Pulling on an Angle	3
Figure 2 Horizontal Pulling.....	3
Figure 3 Vertical Lifting	3
Figure 4 Angle Pulling.....	4
Figure 5 Latch Hook Opening	6
Figure 6 Latchlok Hook Opening	6
Figure 7 Gaging Load Chain Wear	7
Figure 8 Ratchet & Ratchet Plunger Assembly	8
Figure 9 Brake Parts	8
Figure 10 Brake Nut Cotter Pin Assembly	9
Figure 11 Lever Assembly	9
Figure 12 Chain Assembly - Hook End, 3/4 Ton	9
Figure 13 Chain Assembly - Hook End, 1-1/2 Ton	10
Figure 14 Reeving 3-Ton.....	10
Figure 15 Reeving 6-Ton.....	10
Figure 16 Exploded View 3/4-6 Ton	13-14
Figure 17 Cutting Chain By Nicking	15
Figure 18 Cutting Chain With a Bolt Cutter.....	15
Figure 19 Load Limiter	17

GENERAL INFORMATION

SPECIFICATIONS

Yale Manually Lever Operated Hoist is a highly versatile tool that can be used to efficiently pull, lift, drag, or stretch. The load chain is strong and durable Hoistaloy®. The frame and lever are made of lightweight aluminum alloy. An automatic brake supplies positive load control and will suspend the load at any point. Latch type hooks are standard on all capacities.

The standard lift of the lever hoist is 5 feet (1.5 mm). However, hoists with longer lift can be supplied on a special, per order basis.

Load Limiter and Load Sentry are optional items for Yale Lever Hoists. The optional Anchor Sling is available for the 3/4 and 1-1/2 ton Hoists. Latchlok upper and lower hooks are optional items for all Yale Lever Hoists.

Code	Capacity (Tons)	Pull On Lever To Lift Full Load Lbs(kg)	Net Weight Lbs(kg)	Minimum Distance Between Hooks In.(mm)
931-04108	3/4	58 (26)	14 (6.4)	10-3/4(273)
931-06108	1-1/2	83 (38)	24 (10.8)	14-1/4(362)
931-09108	3	95 (43)	35 (15.6)	17(432)
931-14108	6	96 (44)	70 (31.8)	21-3/8(543)
4081	3/4	Load Limiter Kit (Standard Lever Only)		
4083	1-1/2-6			
4071	3/4	Anchor Sling Kit		
4072	1-1/2			
4085	3/4	Load Sentry Kit		
4086	1-1/2-6			

YALE HOIST REPAIR/REPLACEMENT POLICY

All Yale Lever Hoists are thoroughly inspected and performance tested prior to shipment. If any properly maintained hoist develops a performance problem due to a material or workmanship defect, as verified by Yale, repair or replacement of the unit will be made to the original purchaser without charge. This repair/replacement policy applies only to lever hoists installed, maintained and operated as outlined in this manual, and specifically excludes parts subject to normal wear, abuse, improper installation, improper or inadequate maintenance, hostile environment effects, and unauthorized repairs/modifications.

We reserve the right to change materials or design if, in our opinion, such changes will improve our product. Abuse, repair by an unauthorized person, or use of non-Yale replacement parts voids the guarantee and could lead to dangerous operation. For full Terms of Sale, see Sales Order Acknowledgment. Also, refer to the back cover for Limitations of Warranties, Remedies and Damages and, Indemnification's and Safe Operation.



OPTIONAL LOAD LIMITER

LOAD LIMITER

The Load Limiter is a friction device that is designed and factory calibrated to prevent the lifting of excessive overloads with 3/4, 1-1/2, 3 and 6 Ton Yale Lever Hoists. Excessive overload is indicated by lever movement without the corresponding movement of the lower hook block or load when the unit is operated in the "Up" direction. Should overload be evident, immediately switch the trigger to "Down" direction and operate the lever to remove the excess load from the unit. The reduction of the load to rated capacity or less will result in automatic restoration of normal operation.

Load Limiter assures positive warning of overload condition. You may order the Load Limiter as part of your new hoist or in kit form for easy installation in units with standard levers now in use. The Load Limiter is designed for use on the Yale Lever Hoist only. For additional information on the Load Limiter refer to page 17.

ANCHOR SLING (3/4 and 1-1/2 Ton Units)

Anchor Sling is an upper hook extender that simplifies attachment when application or space limitation makes it impossible to pull in a straight line from hook to hook. A swiveling hook block is securely anchored to the hoist housing and the upper hook swivels through a full 360 degrees. Anchor Sling may be ordered as a feature of your new lever hoist or in kit form for simple installation on units now in use.

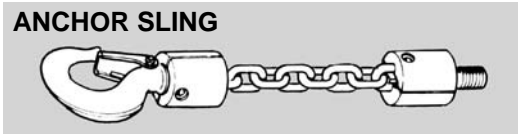

HOOKS

Type of hooks supplied on the Yale Lever Hoists.

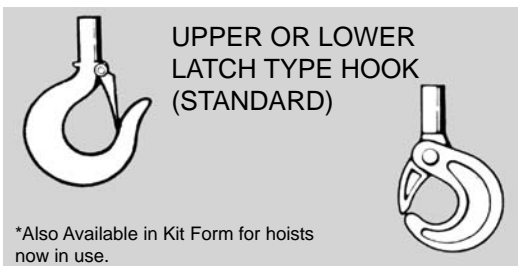

*Also Available in Kit Form for hoists now in use.

LOAD SENTRY

The Load Sentry is an overload indicating device. When dangerous overloads, in excess of rated capacity, are applied to the unit, the Load Sentry grip gradually deflects with increasing overloads to warn of the danger involved.

 WARNING
GRIP DEFLECTION DENOTES DANGEROUS OVERLOADING.
TO AVOID INJURY: DO NOT CONTINUE OPERATION AT LEVER FORCES WHICH CAUSE GRIP DEFLECTION.

Since calibration is permanent and is pre-set by the factory, the user should not tamper with the calibration nor should repair be made by the user.

LOAD SENTRY

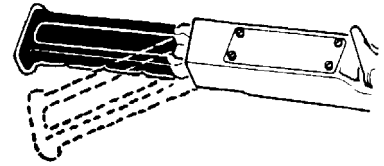

Load Sentry assures positive warning of overload condition. You may order Load Sentry as part of your new hoist or in kit form for easy installation in units now in use. The Load Sentry is designed for use on the Yale Lever Hoist only.

INSTALLATION AND OPERATION

UNPACKING INFORMATION

After removing the lever hoist from the carton, check to be sure there has been no damage in shipment. If shipping damage has occurred, refer to the packing list envelope on the carton for claim procedure. Before cutting the chain ties on multiple-reeved units, be sure that all strands of chain are straight with no twist (due to a capsized hook block). If length of lift is to be modified, follow disassembly and assembly instructions for correct procedure. Make certain that the hook side of the chain is on the side of the hoist marked "lower hook side" on the chain guide.

INSTALLATION

The lever hoist can be used in any position provided it is rigged to pull in a straight line from hook to hook.

Figures 1 through 3 show proper operation for common applications. It is important that the frame is free to swivel on the upper hook. Under no condition should the frame be allowed to touch the load or bear on any support when in use as this might cause bending of the hook or frame and possible failure. When operating in limited areas it is recommended that lifting attachments or slings be used to keep the frame and lever from being obstructed.

 WARNING
IF THE UNIT IS NOT RIGGED IN A STRAIGHT LINE HOOK TO HOOK MANNER, AND IF THE FRAME IS NOT FREE TO SWIVEL, LEVER PULL MAY BREAK FRAME AND CAUSE PHYSICAL INJURY AND LOSS OF LOAD.
TO AVOID INJURY: RIG THE UNIT IN A STRAIGHT LINE HOOK TO HOOK MANNER AND KEEP FRAME FREE TO SWIVEL - SEE FIGURE 4.



Figure 1. Pulling on an Angle



Figure 2. Horizontal Pulling



Figure 3. Vertical Pulling

OPERATING INSTRUCTIONS

! WARNING
IF NOT USED AS DIRECTED, YALE LEVER HOIST MAY CAUSE INJURY.
TO AVOID INJURY: USE ONLY AS DIRECTED BELOW.

Free Wheeling - In this mode brake and lever are disengaged to allow chain to be pulled through the Hoist by hand, for quick and easy attachment to the load.

To put lever hoist in free wheeling:

- (1) Be sure unit is **not** loaded.
- (2) Pull out ratchet plunger.
- (3) Turn ratchet plunger 1/4 turn left or right.
- (4) Turn the lever trigger 1/4 turn from "UP" or "DOWN".

! WARNING
PULLING OUT OR TURNING THE RATCHET PLUNGER WITH A LOAD ATTACHED WILL ALLOW THE LOAD TO RELEASE AND MAY CAUSE INJURY.
TO AVOID INJURY: NEVER PULL OR TURN RATCHET PLUNGER WHEN THE HOIST IS UNDER LOAD.

Grasp the hoist by the frame or upper hook and pull on the end ring or lower hook to pull the chain through the unit. **DO NOT** hold the lever when free chaining as this may cause the chain to jam in the unit.

After attaching to the load, turn ratchet plunger 1/4 turn until it snaps into engagement and turn lever trigger to "UP" or "DOWN" for further use.

! WARNING
IF THE UNIT IS NOT RIGGED IN A STRAIGHT LINE HOOK TO HOOK MANNER, AND IF THE FRAME IS NOT FREE TO SWIVEL, LEVER PULL MAY BREAK FRAME AND CAUSE PHYSICAL INJURY AND LOSS OF LOAD.
TO AVOID INJURY: RIG THE UNIT IN A STRAIGHT LINE HOOK TO HOOK MANNER AND KEEP FRAME FREE TO SWIVEL - SEE FIGURE 4.

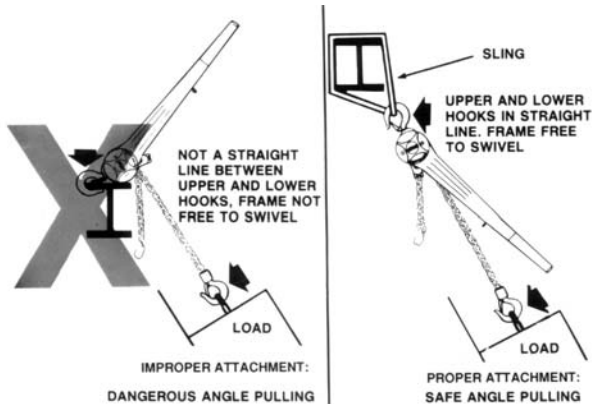

Figure 4. Angle Pulling

Attaching Load - As discussed in installation section, attach load so that upper and lower hooks are in a straight line with the frame free to swivel on upper hook. If proposed use prevents straight line attachment, use an Anchor Sling (see page 2) or chain sling to obtain a straight line pull. Refer to Figure 4.

To Pull or Lift Load - Put lever trigger in "UP" position. Lever pull in "UP" position shortens distance between hooks. Observe that ratchet plunger is not changed when changing from "UP" to "DOWN" or "DOWN" to "UP" positions.

! WARNING
MALFUNCTION OF UNIT, RIGGING SLIP OR LOSS OF FOOTING MAY CAUSE USER TO SLIP RESULTING IN INJURY.
TO AVOID INJURY: ALWAYS HAVE A FIRM AND SECURE FOOTING WHEN USING THE HOIST.

To Loosen or Lower Load - Put lever trigger in "DOWN" position. Lever pull in "DOWN" position increases distance between hooks.

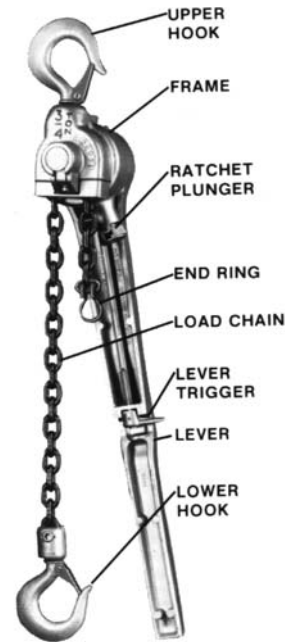

Main Parts of Yale Lever Hoist

! WARNING-TO AVOID INJURY:
Use as directed above. Failure to do so may cause injury to you or others.
<ol style="list-style-type: none"> 1. Do not exceed capacity shown on frame or lower hook block. 2. Do not use to lift people or loads over people. 3. Do not use unless the hoist's frame and chain form a straight line between hooks. 4. Do not use if the frame is in contact with any object. 5. Do not use if the unit is damaged or malfunctions. 6. Do not use extension on lever. Use hand power only. 7. Do not use if chain is twisted, kinked or damaged.

NOTE: Refer to page 17 for information pertaining to the operation of units equipped with the Load Limiter.

Inspect Hoist before each use and at specified intervals as directed in inspection section.

1. When preparing to lift or move a load be sure that the attachments both hooks are firmly seated in the saddles of the hooks. Avoid off-center loading of any kind especially loading on the point of the hook. Do not load the hook latch as it is to retain slack chain as an aid in hook-up only.

 WARNING
ALLOWING THE LOAD TO BEAR AGAINST THE HOOK LATCH AND/OR HOOK TIP CAN RESULT IN LOSS OF LOAD.
TO AVOID INJURY: DO NOT ALLOW THE LOAD TO BEAR AGAINST THE HOOK LATCH AND/OR HOOK TIP. APPLY LOAD TO HOOK BOWL OR SADDLE ONLY.

2. When lifting or pulling, raise or move the load only enough to clear the floor or support. Check to be sure brake will hold load and that attachments to hooks and load are firmly seated. Continue the lift only after you are assured the load is free of all obstructions.
3. Do not load beyond the rated capacity. Overload can cause immediate failure of some load carrying part or create a defect causing future failure at less than rated capacity. When in doubt, use the next larger capacity of Yale Lever Hoist.
4. As shown in the lever pull table approximately 100 pounds (44kg.) maximum is required to pull rated load. Operate by hand only and do not use an

Lever Pull To Lift Rated Load	
Capacity (Tons)	Lever Pull Lbs/ (kg.)
3/4	58 (26)
1-1/2	83 (38)
3	95 (43)
6	96 (44)

extension on lever. A need for an extension is an indication of either an overload or an incorrectly maintained unit. Use a Hoist of adequate capacity which is in good operating condition.

5. Under no condition should any attempt be made to pry the ratchet plunger out of engagement when a load is on the unit, as this allows the load to fall.

 WARNING
PULLING OUT OR TURNING THE RATCHET PLUNGER WITH A LOAD ATTACHED WILL ALLOW THE LOAD TO RELEASE AND MAY CAUSE INJURY.
TO AVOID INJURY: DO NOT PRY THE RATCHET PLUNGER OUT OF ENGAGEMENT WHEN A LOAD IS ON THE HOIST.

6. Do not use this or any other overhead materials handling equipment for lifting persons.
7. Stand clear of all loads and avoid moving a load over the heads of other personnel. Warn personnel of your intention to move a load in their area.
8. Do not leave the load applied in an unattended manner.
9. Do not lower load chain to the point where the end ring becomes jammed against frame. (See Trouble Shooting chart on page 16).
10. The Yale Lever Hoist has been designed for hand powered operation only.
11. Do not wrap the load chain around the load and hook onto itself as a choker chain.
12. Do not wrap load chain around the load or bring the load in contact with the hoist. Doing this will result in the loss of the swivel effect of the hook which could mean twisted chain and a jammed liftwheel. The chain could be damaged at the hook.
13. Do not operate the hoist unless it is rigged to pull in a straight line from hook to hook, **and** the frame is free to swivel on the upper hook. Refer to Figure 4.
14. Never operate the hoist when flammable materials or vapors are present. Contact between metal parts may produce sparks that can cause a fire or explosion.
15. **STAY ALERT!** Watch what you are doing and use common sense. Do not use the hoist when you are tired, distracted or under the influence of drugs, alcohol or medication causing diminished control.

INSPECTION

To maintain continuous and satisfactory operation, a regular periodic inspection procedure must be initiated so that worn, damaged and missing parts can be replaced before the unit becomes unsafe. The frequency of inspection must be determined by the individual application.

The following list gives an inspection procedure for normal usage under normal conditions.

When the unit is subjected to heavy usage or dusty, gritty, moist or corrosive atmospheric conditions, shorter time periods must be assigned. Inspection must be made of all parts for unusual wear, corrosion or damage, in addition to those specifically mentioned in the schedule below. Make certain that the unit is complete and contains all parts including hook latches and end ring.

Any parts that are deemed unserviceable must be replaced with new parts before the unit is returned to service. It is very important that the unserviceable parts be destroyed and properly disposed of to prevent their possible future use as a repair item. Use only Yale supplied repair parts as other parts may look the same but may not be to proper specifications.

Inspection of hoists is divided into two general classifications designated as "frequent" and "periodic".

FREQUENT INSPECTIONS

These inspections are by the operator or other designated personnel. Frequent inspections are to be performed daily or prior to each use and they are to include the following:

- A. Check for free movement of lever, lever plunger, trigger and ratchet plunger.
- B. Operate hoist with no load and check for visual signs or abnormal noises that could indicate a potential problem.
- C. Check brake for evidence of slippage.
- D. Check chain for lubrication, wear damaged links or foreign material (see page 6).
- E. Check hooks for damage, cracks, twist, latch engagement and latch operation (see page 6).
- F. Check lever for bends, cracks and damage.
- G. Check support or anchor for damage.
- H. Check reeving of chain (see page 9).

Any deficiencies noted during the frequent inspections must be corrected before using the hoist.

PERIODIC INSPECTIONS

These are visual inspections by an appointed person who records conditions to provide a basis for a continuing evaluation of the hoist. Periodic inspections are to be performed semi-annually and they should include the following:

- A. All items listed under frequent inspections.
- B. Evidence of loose screws.
- C. Evidence of worn, cracked, damaged or distorted lower hook blocks, frame, end ring, loose end link, hook block screws, lever, gears, bushings, loose end link, hook block screws, lever, gears, bushings, lever plunger, lever ratchet hub, brake cam, ratchet, friction hub, liftwheel, chain guide, ratchet plunger, stripper, hoist hanger, lever cap, disc spring, hook nut, hook nut pin, hanger screw, hanger screw nut, hanger screw nut pin, dead end pin, idler sheaves and load limiter parts, as applicable.
- D. Evidence of worn, glazed or oil contaminated friction discs. Friction discs should be replaced if their thickness is less than 0.100 inch (2.5 mm).
- E. Warning label for legibility.

NOTE: To perform some of the periodic inspections, it is necessary to partially disassemble the hoist. Refer to Disassembly-Assembly starting on page 8. Also, the external conditions may show the need for more detailed inspection which, in turn, may require the use of non-destructive type testing.

HOOK INSPECTION

Hooks damaged from chemicals, deformations or cracks, or that have more than a 10 degree twist from the plane of the unbent hook or excessive opening or seat wear must be replaced.

Also, on latch type hooks, hooks that are opened and allow the latch to disengage the tip, must be replaced.

Any hook that is twisted or has excessive throat opening indicates abuse or overloading of the unit. Other load sustaining components of the hoist should be inspected for damage.

Check to assure latch is not damaged or bent and that it operates properly with sufficient spring pressure to keep the latch tightly against the tip of the hook and allow the latch to spring back to the tip when released. If the latch does not operate properly, it should be replaced.

The charts above (Figures 5 and 6) should be used to determine when the hook must be replaced.

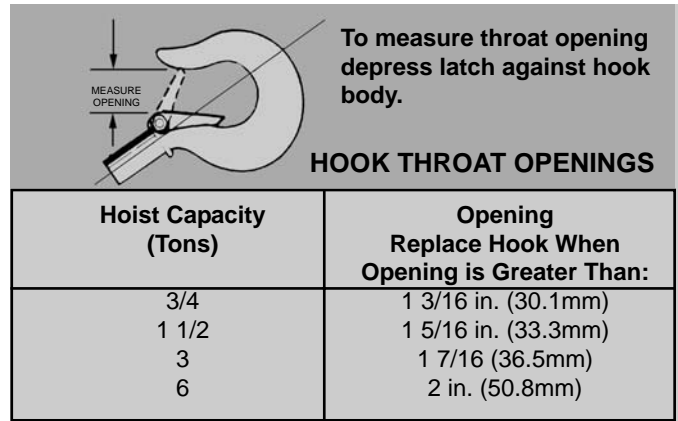

Figure 5. Latchlok Hook Throat Opening

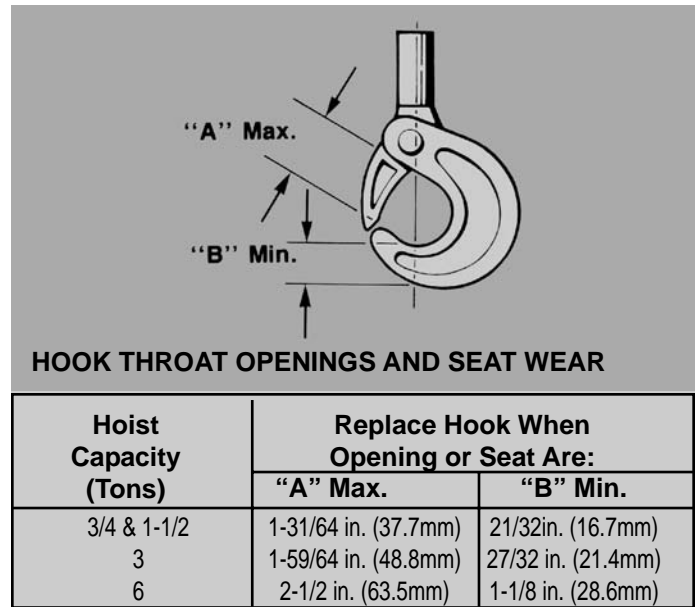
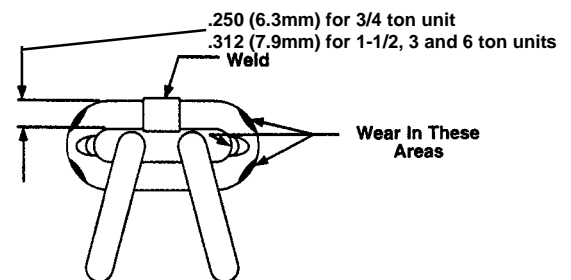

Figure 6. Latchlok Hook Opening

CHAIN INSPECTION

First clean chain with a non-caustic/non-acid type solvent and make a link by link inspection for nicks, gouges, twisted links, weld spatter, corrosion pits, striations (minutes parallel lines), cracks in weld areas, wear and stretching. Chain with any one of these defects must be replaced.

Slack the portion of the chain that normally passes over the liftwheel. Examine the interlink area for the point of maximum wear (polishing). Measure and record the stock diameter at this point of the link. Then measure stock diameter in the same area on a link that does not pass over the liftwheel (use the link



adjacent to the end ring for this purpose). Compare these two measurements. If the stock diameter of the worn link is 0.010 inches (0.254 mm), or more, less than the stock diameter of the unworn link, the chain must be replaced.

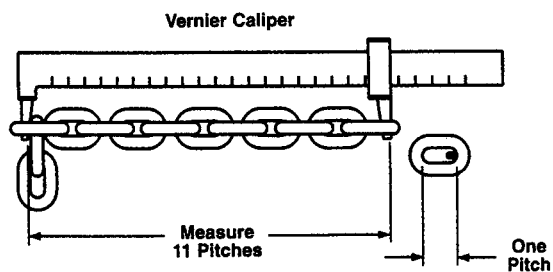



Figure 7. Gaging Load Chain Wear

Also check chain for stretch using a vernier caliper as shown above. Select an unused, unstretched section of chain (usually at the loose end) and measure and record the length over 11 chain links (pitches). Measure and record the same length on a worn section of chain. Obtain the amount of stretch and wear by subtracting the measurement of the unworn section from the measurement of the worn section. If the result (amount of stretch and wear) is greater than 0.145 inch (3.7 mm), the chain must be replaced.

Use only a “Knife-Edge” caliper to eliminate possibility of false reading by not measuring full pitch length. Note that worn chain can be an indication of worn hoist components. For this reason, the hoist’s frame, stripper, and liftwheel should be examined for wear and replaced as necessary when replacing worn chain.

Also, the load chain is specially heat treated and hardened and should never be repaired.

 WARNING
USING OTHER THAN FACTORY SUPPLIED LOAD CHAIN MAY CAUSE THE CHAIN TO JAM IN THE HOIST AND/OR ALLOW THE CHAIN TO BREAK AND THE LOAD TO DROP.
TO AVOID INJURY:
DUE TO SIZE REQUIREMENTS AND PHYSICAL PROPERTIES, USE ONLY HOISTALOY® LOAD CHAIN IN THE YALE LEVER HOIST.

IMPORTANT:

Do not use replaced chain for other purposes such as lifting or pulling. Load chain may break suddenly without visual deformation. For this reason, cut replaced chain into short lengths to prevent use after disposal.

CHAIN LUBRICATION

A small amount of lubricant will greatly increase the life of the load chain. Do not allow the chain to run dry. Keep it clean and lubricate at regular intervals with Lubriplate® Bar and Chain Oil 10-R (Fiske Bros. Refining Co.) or equal lubricant. Normally, weekly cleaning and lubrication is satisfactory, but under hot and dirty conditions, it may be necessary to clean the chain at least once a day and lubricate it several times between cleanings.

When lubricating the chain, apply sufficient lubricant to obtain natural run-off and full coverage, especially in the interlink area.

 WARNING
USED MOTOR OILS CONTAIN KNOWN CARCINOGENIC MATERIALS.
TO AVOID HEALTH PROBLEMS:
NEVER USE USED MOTOR OILS AS A CHAIN LUBRICANT. ONLY USE LUBRIPLATE® BAR AND CHAIN OIL 10-R AS A LUBRICANT FOR THE LOAD CHAIN.

MAINTENANCE

LUBRICATION

Except for the load chain (see “Chain Lubrication” above), the hoist requires no additional lubrication.

 WARNING
THE LUBRICANTS USED IN AND RECOMMENDED FOR THE HOIST MAY CONTAIN HAZARDOUS MATERIALS THAT MANDATE SPECIFIC HANDLING AND DISPOSAL PROCEDURES.
TO AVOID CONTACT AND CONTAMINATION:
HANDLE AND DISPOSE OF LUBRICANTS ONLY AS DIRECTED IN APPLICABLE MATERIAL SAFETY DATA SHEETS AND IN ACCORDANCE WITH APPLICABLE LOCAL, STATE AND FEDERAL REGULATIONS.

However, when the unit has been disassembled for cleaning, inspection or repairs, the various parts should be lubricated as indicated in “Assembly” start on page 8 using the specified lubricants. If necessary, these lubricants can be obtained from Yale (refer to page 15).

 WARNING
USING ANY GREASE OR LUBRICANT ON THE BRAKING SURFACES WILL CAUSE BRAKE SLIPPAGE AND LOSS OF LOAD CONTROL WHICH MAY RESULT IN INJURY AND/OR PROPERTY DAMAGE.
TO AVOID INJURY:
DO NOT USE ANY GREASE OR LUBRICANT ON BRAKING SURFACES. THE BRAKE IS DESIGNED TO OPERATE DRY.

Note: When lubricating parts adjacent to the brake, do not use an excessive amount of lubricant which could seep onto the brake surfaces.

EXTERIOR FINISH

The exterior surfaces of the Yale Lever Hoist has a durable, scratch resistant baked powder coating. Normally, the exterior surfaces can be cleaned by wiping with a cloth. However, if the finish is damaged, compatible touch-up paint can be purchased from Yale. Refer to page 16 for information on ordering the paint.

PREVENTIVE MAINTENANCE

In addition to the above frequent inspection procedure, a maintenance program should be established to prolong the useful life of the hoist and maintain its reliability and continued safe use. The program should include the frequent inspections with particular attention being paid to the lubrication of various components using the recommended lubricants. Be sure to completely disassemble the unit every three months and check for excessive wear of the parts. Worn parts should be replaced before the hoist is returned to service.

RECOMMENDED SPARE PARTS

To insure continued operation of the Yale Lever Hoist, it is recommended that two friction washers for each Hoist in service, Key No. 640-123, Part Number 40904, be kept on hand at all times to replace friction washers that are worn to a thickness of less than 0.100 (2.5 mm) inch, contaminated or glazed. Refer to page 11 for ordering instructions.

DISASSEMBLY

(Refer to pages 11 thru 14 for illustrations and key numbers of parts listed below. Also, see special disassembly instructions on page 17 for units equipped with Load Limiter).

Two points of caution to be observed in disassembly are:

1. When removing the Ratchet Plunger Spring Pin (640-131). This pin retains a spring which is in compression and can spring out.
2. The dead end pin on the 3 and 6 ton units has a tapered spline. Remove this pin by tapping on the end opposite the splined grooves.

ASSEMBLY

(Refer to pages 11 thru 14 for illustrations and key numbers of parts listed below. Also, see special assembly instructions on page 17 for units equipped with Load Limiter).

IMPORTANT: Following assembly test the unit as discussed in the Testing section (page 15).

The following points should be observed when assembling the hoist. Also, refer to the above Warning concerning the brake.

1. Ratchet Plunger

- A. Coat tip and sides of small diameter with a light film of a lubricant consisting of 1 lb. (.46 kg) of graphite #590 (Superior Graphite Co.) and 2 lbs. (.92 kg.) of Lubriko M-32 (Master Lubricant Co.).
- B. The Ratchet Plunger Spring must be held depressed when driving in the Ratchet Plunger Pin thru the lugs on the frame.

2. Frame Bushing

- A. All Frame Bushings should be given a light coating of lubricant as specified above.

3. Brake Assembly

- A. Assemble one Friction Washer.
- B. Check Bushing in Ratchet (640-124) to be sure it is flush or below the surface of the Ratchet on both sides. Assemble Ratchet with Ratchet Teeth facing as showing in Fig. 8.

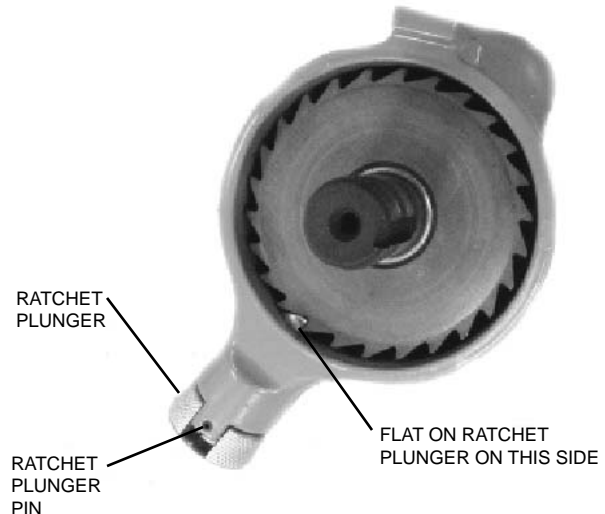

Figure 8. Ratchet and Ratchet Plunger Assembly

- C. Place second Friction Washer on the Ratchet.
- D. Apply a light film of Anderol #786 (Nuodex, Inc.) to the inside diameter of the Lever Ratchet Hub and place on top of the second friction washer as shown in Figure 9.
- E. Lubricate Brake Cam (640-126) by coating cam faces and outside surface with a light film of Anderol #786 (Nuodex, Inc.) grease.
- F. Assemble Brake Cam onto shaft then insert Brake Cam Key (640-110) rounded end first - the key must be positioned as shown in Fig. 9.

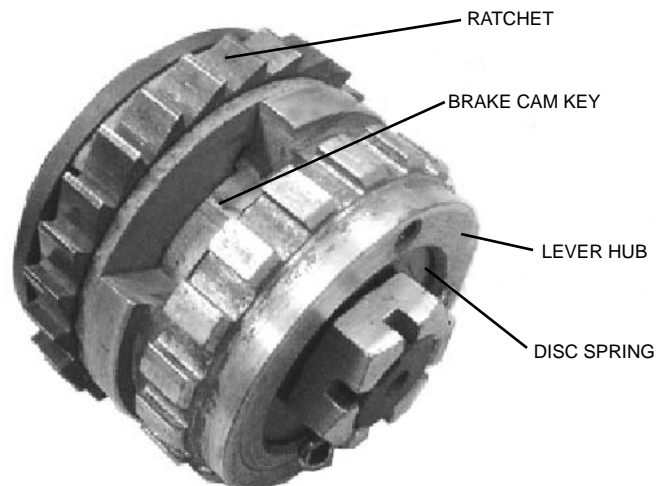

Figure 9. Brake Parts

- G. Turn Lever Ratchet Hub clockwise until vertical ends (shoulders) of the helical surfaces of lever ratchet hub and brake cam are in contact. Place the disc spring on the brake cam with the large end against the brake cam. Assemble brake adjusting nut to shaft and tighten nut until snug. Then continue to tighten nut at least one but no more than two slots in order to align hole in shaft with slot in nut. Insert the cotter pin and bend the ends of same as shown in Fig. 10.

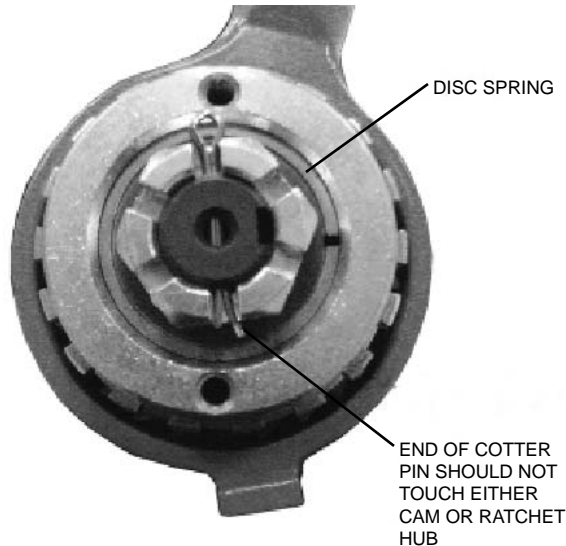

Figure 10. Brake Nut Cotter Pin Assembly

4. **Gears (1-1/2, 3 & 6 Ton Units)**
 - A. Lubricate the gears with 3-1/2 to 4 oz. (118 ml) of Texaco Novatex #2 Grease or equal, by spreading some on Gear Teeth and balance in the lower portion of Gear Cover.
5. **Chain Guide (1-1/2, 3 & 6 Ton Units)**
 - A. When installing the Chain Guide, the Chain Guide Screw must be tightened to a torque of 10 to 13 inch pounds.
6. **Lever Assembly**
 - A. Coat Lever Plunger (640-176) tip for a length of 1-1/2 inches (38mm) with a lubricant consisting of 1 oz. of graphite #590 (Superior Graphite Co.) and 1qt. (946 ml) of Acheson #DAG-1556 dry film lubricant (Acheson Collids Co.)
 - B. When assembling Lever Trigger (640-180) be sure to maintain relation of Lever Plunger tip and Lever Trigger as shown in Fig. 11.
 - C. Coat inside of Lever Head with Lubriko M-32. Wipe off excess lubricant.

IMPORTANT: To assure extra long life and top performance, be sure to lubricate the various parts of the Yale Lever Hoist using the lubricants specified above. If necessary, these lubricants

may be purchased from Yale. Refer to page 15 for information on ordering the lubricants.

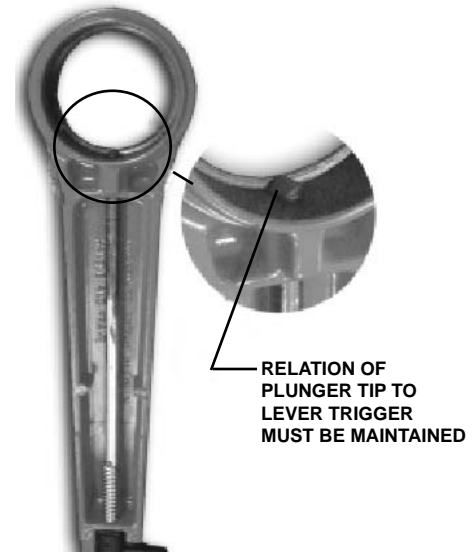

Figure 11. Lever Assembly

REEVING

NOTE: Units should be in the free wheeling mode before reeving. See page 4.

- A. **3/4 Ton Unit Uses 1/4 in. (6.3mm) Stock Disc Grade Load Chain.**
Start upstanding link (see Fig. 12) of hook end of load chain into Plunger Boss side (at side opposite that is marked on the chain guide "Lower Hook Side") of clover leaf chain guide and onto liftwheel with weld side of upstanding links facing away from liftwheel. Continue to feed chain into opening while turning Lever Cap clockwise until end of chain can be reached and pulled through. Do not force chain over liftwheel - if turning of Lever Cap becomes difficult, back off and start over - otherwise, the chain could become jammed between liftwheel and frame.



Figure 12. Chain Assembly - Hook End, 3/4 Ton

B. 1-1/2 Ton Unit Uses 5/16 in. (7.9mm) Stock Disc Grade Load Chain.

Start upstanding link (see Fig. 13) of hook end of load chain onto liftwheel (at side opposite that marked on casting "Lower Hook Side") with weld side of upstanding links facing away from liftwheel (at side opposite that marked on casting "Lower Hook Side") with weld side of upstanding links facing away from liftwheel. Continue to feed chain onto liftwheel while turning Lever Cap clockwise until end of chain can be reached and pulled through. Do not force chain over liftwheel - if turning of Lever Cap becomes difficult, back off and start over - otherwise, the chain could become jammed between liftwheel and frame.



Figure 13. Chain Assembly - Hook End, 1 1/2 Ton

C. 3 Ton Uses 5/16 in. (7.9mm) Stock Disc Grade Load Chain.

- Start upstanding link (see Fig. 13) of dead end (end opposite end ring) onto liftwheel (at side opposite that marked on casting "Lower Hook Side") with weld side of upstanding links facing away from liftwheel. Continue to feed chain onto liftwheel while turning Lever Cap clockwise until end of chain can be reached. Pull through about three feet of chain. Do not force chain over liftwheel - if turning of Lever Cap becomes difficult, back off and start over - otherwise, the chain could become jammed between liftwheel and frame.
- Place the hoist in vertical position.
- After checking to be sure there is no twist in chain, feed end of chain through Hook Block and around Lower Sheave.
- Secure end of chain to Hoist Hanger with Dead End Pin (640-144)

D. 6 Ton Unit Uses 5/16 in. (7.9mm) Stock Disc Grade Load Chain.

- Start first link of dead end (end opposite End Ring) onto Liftwheel in flat position (at side opposite that marked on casting "Lower Hook Side") with weld side of upstanding links facing away from Liftwheel. Continue to feed chain onto Liftwheel while turning Lever Cap clockwise until end of chain can be reached. Pull through about six feet of chain. Do not force Chain over Liftwheel if turning of Lever Cap becomes difficult, back off and start over -



Figure 14. Reeving 3-Ton

otherwise, the chain could become jammed between Liftwheel and Frame.

- Place the hoist in vertical position.
- After studying Fig. 15 and checking to be sure there is no twist in chain, feed end of chain down through Hook Block and around one lower Sheave, up over upper Sheave, down through Hook Block and around second lower Sheave.
- Secure end of chain to the Hanger with Dead End Pin (640-147).

E. All Units

- Lubricate chain with Lubriplate®, Bar and Chain Oil 10-R (Fiske Bros. Refining Co.) or equal Lubricant.
- Important: Load Chain End Ring should be assembled and left on end of the load chain to prevent chain from being run out of unit.**



Figure 15. Reeving 6-Ton

F. 3/4 and 1-1/2 Ton Units

- Coat undersides of hook Knob and Seat of Hook Blocks with a light film of Lubriko M-32 (Master Lubricants Co.) or equal grease.
- After tightening Hook Block Screw, lock in place by prick punching two spots 180 apart on edge of counterbore to drive metal in to serrations of head of screw. If screw has been removed and replaced, always use new spots for locking.

G. Test the unit as discussed in the Testing section (page 15).

REPAIR PARTS

ORDERING INFORMATION

The following information must accompany all correspondence or repair parts orders.

- 1) Yale Lever Hoist capacity
- 2) Serial Number - this is stamped on the hoist frame (640-100 or 640-101).

For parts orders also specify

- 1) Quantity desired
- 2) Key number of part
- 3) Part Name
- 4) Part number of the part

When ordering replacement parts, consideration should be given to the need to replace other items, (bushings, fasteners, etc.) and items that may be damaged or lost

during disassembly or just unfit for future use because of deterioration from age or service.

Parts should be ordered from Yale Authorized Hoist Parts Depots conveniently located throughout the United States. Refer to the inside of the front cover of this manual to locate the Hoist Parts Depot nearest you.

 WARNING
USING "COMMERCIAL" OR OTHER MANUFACTURER'S PARTS TO REPAIR THE YALE LEVER HOIST MAY CAUSE LOAD LOSS.
TO AVOID INJURY:
USE ONLY FACTORY SUPPLIED REPLACEMENT PARTS. PARTS MAY LOOK ALIKE BUT YALE PARTS ARE MADE OF SPECIFIC MATERIALS OR PROCESSED TO ACHIEVE SPECIFIC PROPERTIES.

YALE PE2 LEVER HOIST PARTS LIST						
KEY NO.	NO. REQ'D.	PART NAME	PART NUMBER			
			CAPACITY - TONS			
			3/4	1½	3	6
640-100	1	Frame with Bushings (3/4 Tons)	40684Y	-		
640-101	1	Frame with Bushings (1½-6 Tons)	-	40695Y	40695Y	
640-102	1	Frame Expansion Plug	940787	-		
640-103	1	Stripper Screw	982688	-		
640-104	2	Chain Guide Attaching Screw	987274	-		
640-105	1	Stripper	40728	-		
640-106	2	Gear Cover Screw	-	982689		
640-107	1	Chain Guide Attaching Screw	-	982565		
640-108	1	Friction Hub Key	-	40917		
640-109	1	Pinion Thrust Washer	-	40789		
640-110	1	Brake Cam Key	40824			
640-111	1	Brake-Adjusting Nut	40758			
640-112	1	Brake Adjusting Nut Cotter Pin	940805			
640-113	2	Lever Cap Screw	982717			
640-114	1	Liftwheel	40130	40140		
640-115	1	Chain Guide	40698	24718		
640-116	1	Liftwheel Bushing (Gear End)	-	40816		
640-117	1	Liftwheel Bushing (Brake End)	-	40819		
640-118	1	Pinion Shaft Bushing (Brake End)	-	40818		
640-119	1	Pinion Shaft Bushing (Pinion End)	-	40819		
640-120	1	Gear Cover	-	40209	40217	
640-121	1	Pinion Shaft	-	40480		
640-122	1	Friction Hub	-	40446		
640-123	2	Friction Washer	40904			
640-124	1	Ratchet with Bushing	40662			
640-125	1	Lever Ratchet Hub For Units Not Equipped With Load Limiter	40570			
640-126	1	Brake Cam	40122			
640-127	1	Lever Assembly (Includes Lever, Expansion Plug, Plunger, Plunger Spring, Spring Pin Trigger, Trigger Pin, Warning Label and Nameplate)	40190 For Units Without Load Limiter 40191 For Units With Load Limiter			
640-128	1	Load Sentry Assembly	4085	4086		
640-129	1	Ratchet Plunger	40517			
640-130	1	Ratchet Plunger Spring	40742			
640-131	1	Ratcher Plunger Spring Pin	983880			
*640-132	1	Upper Hook Assembly (Includes Latch)	40601	40603	40605	40607
640-133	1	Upper Hook Nut or Collar	986383	40445	40382	70393
640-134	1	Upper Hook Pin	983768	45841	982335	983787
640-135	1	Upper Hook Washer	45941			40736
640-136	1	Anchor Sling	4071	4072	-	
640-137	1	Lever Cap	40150			

YALE PE2 LEVER HOIST PARTS LIST-(Continued)

KEY NO.	NO. REQ'D.	PART NAME	PART NUMBER			
			CAPACITY - TONS			
			3/4	1½	3	6
640-138	1	Disc Spring	82297			
640-139	1	End Ring	40471			
640-140	1	Hoist Hanger	-		40151	40171
640-141	1	Adapter Sleeve	-		40790	-
640-142	1	Hanger Screw (3Ton)	-		982587	-
640-143	1	Hanger Screw Washer (3 Ton)	-		940807	-
640-144	1	Dead End Pin (3 Ton)	-		40851	-
640-145	1	Hoist Hanger Set Screw (3 Ton)	-		986304	-
640-146	1	Hanger Screw (6 Ton)	-			40500
640-147	1	Dead End Pin (6 Ton)	-			40853
640-148	1	Bearing Retainer Snap Ring	-			40740
640-149	1	Hanger Screw Washer (6 Ton)	-			45930
640-150	1	Hanger Screw Nut (6 Ton)	-			40383
640-151	1	Hanger Screw Nut Pin (6 Ton)	-			983791
640-152	1	Upper Sheave	-			40172
640-153	2	Upper Sheave Bearing	-			88429
*640-154	1	Lower Hook Assembly (Includes Latch)	40602	40604	-	-
640-155	1	Hook Block Drilled	40120	40142	-	-
640-156	1	Hook Block Tapped	40121	40143	-	-
640-157	1	Hook Block Screw	40854	40855	-	-
*640-158	1	Lower Hook Assembly (Includes Latch)	40602	40604	40606	40608
640-159	1	Lower Hook Washer	-		50454	40736
640-160	1	Lower Hook Nut	-		40382	70393
640-161	1	Lower Hook Nut Pin	-		982335	983787
640-162	3	Lower Hook Block Screw	-		940812	-
640-163	3	Lower hook Block Screw L.W.	-		940830	-
640-164	3	Lower Hook Block Screw Nut	-		945820	-
640-165	1	Reeving Caution Plate	-		40930	-
640-166	1	Lower Sheave Bearing Spacer	-			40796
640-167	2	Bearing Retainer Snap Ring	-			40740
640-168	2	Expansion Plug	-			940737
640-169	1	Lower Sheave (3 Ton)	-		40166	-
640-170	2	Lower Sheave (6 Ton)	-			40172
640-171	4	Sheave Bearing (6 Ton)	-			88429
640-172	2	Lower Hook Block (3 Ton)	-		40689	-
640-173	1	Lower Hook Block (6 ton)	-			40176
640-174	1	Load Chain (Specify length required)	85839	85847		
640-175	2	Latch Kit	45661	45662	45663	45665
640-176	1	Lever Plunger	40462			
640-177	1	Lever Expansion Plug	940801			
640-178	1	Lever Plunger Spring	40735			
640-179	1	Lever Plunger Pin	983766			
640-180	1	Lever Trigger	40113			
640-181	1	Lever Trigger Pin	983768			
640-183	1	Warning Label	40975	40978	40979	40980
640-184	1 Ea.	Operating Tag and Tie	Order Tag 40203 and Tie 982979			
640-200	1	Load Limiter Kit (Includes Lever)	4081	4083		
640-201	1	Lever Ratchet Hub for Units Equipped with Load Limiters	40182			
640-202	1	Capacity or Yale Label	-	40205	40207	
640-203	1	Lever Label	40202			

* If Latchlok Hook is required, part numbers are:
 Upper Hook-1000 for 3/4 ton, 1002 for 1-1/2 ton, 1004 for 3 ton and 1027 for 6 ton.
 Lower Hook-1001 for 3/4 ton, 1003 for 1-1/2 ton, 1005 for 3 ton and 1007 for 6 ton.

LOAD LIMITER

The Load Limiter is a friction device that is designed and factory calibrated to prevent the lifting of excessive overloads with the 3/4, 1-1/2, 3 and 6 Ton lever hoists. Excessive overload is indicated by lever movement without the corresponding movement of the lower hook block or load when the unit is operated in the "Up" direction. Should overload be evident, immediately switch the trigger to "Down" direction and operate the lever to remove the excess load from the unit. The reduction of the load to rated capacity or less will result in automatic restoration of normal operation.

CAUTION

The Load Limiter is subject to overheating and wear when excessively actuated. For this reason once overloading is detected, the excess load must be removed and normal operation restored without continued undue operation.

The Load Limiter is designed to operate dry without lubrication. Therefore, to assure proper operation, do not apply lubricant to friction surfaces or to adjacent parts of the Load Limiter.

Follow all the instructions and warnings per pages 3 thru 10 when installing, operating, inspecting and maintaining the hoist equipped with the Load Limiter. When disassembling and reassembling the Load Limiter, refer to Figure 19 and observe the following:

1. To aid in its removal, the hole in the key is threaded. If it is difficult to remove, thread a #10-24 UNC-2A screw into the hole and pull on the screw to remove the key.
2. Place the spacers in the recess of the outer cone and place the Load Limiter spring on top of the spacers.
3. Be sure to tighten the socket head cap screw to

a seating torque of 200 to 250 pound inches (22.6 to 28.2nm). If the screw does not remain tight, apply locking compound, such as VC-3 (Nylok-Detroit) to the threads of the screw per the manufactures recommendations.

Under certain operating conditions, such as applying an overload or removing the load by external means, the brake may become locked. This results in not being able to operate the lever hoist in the "DN" direction. Should this occur, reapply a load to the lower hook. Place the trigger in the "DN" position and give the lever a sharp pull and then a few additional strokes to lower the load and remove the tension from the hoist.

When testing the unit per page 16, reduce the test load to rated capacity if the lever should slip when attempting to lift the 125% of rated capacity load. After this test, the function of the load limiter should be checked. To do this, attach the lower hook to a load of 180% of rated capacity and operate the unit in the "up" direction. When attempting to lift this load, the lever should slip. After this test, move the trigger to the down position and operate the lever to remove the tension from unit.

Since each Load Limiter is individually calibrated, the components of the device are not sold separately as repair parts. If replacement is necessary order the appropriate Load Limiter Kit (refer to parts list). However, the lever ratchet hub, and lever assembly (as well as the components of the lever assembly) used on a Yale Lever Hoist equipped with a Load Limiter can be ordered as repair parts. (Refer to exploded view and parts list on pages 11 thru 14).

 WARNING
<p>THE NUMBER OF SPACERS USED AFFECTS THE CALIBRATION OF THE LOAD LIMITER AND CHANGING THE QUANTITY OF SPACERS WILL RESULT IN THE ABILITY TO OVERLOAD THE LEVER HOIST OR CAUSE THE LEVER TO SLIP AT LESS THAN RATED LOAD.</p>
<p>TO AVOID INJURY: DO NOT ALTER SPACERS PROVIDED WITH THE UNIT.</p>

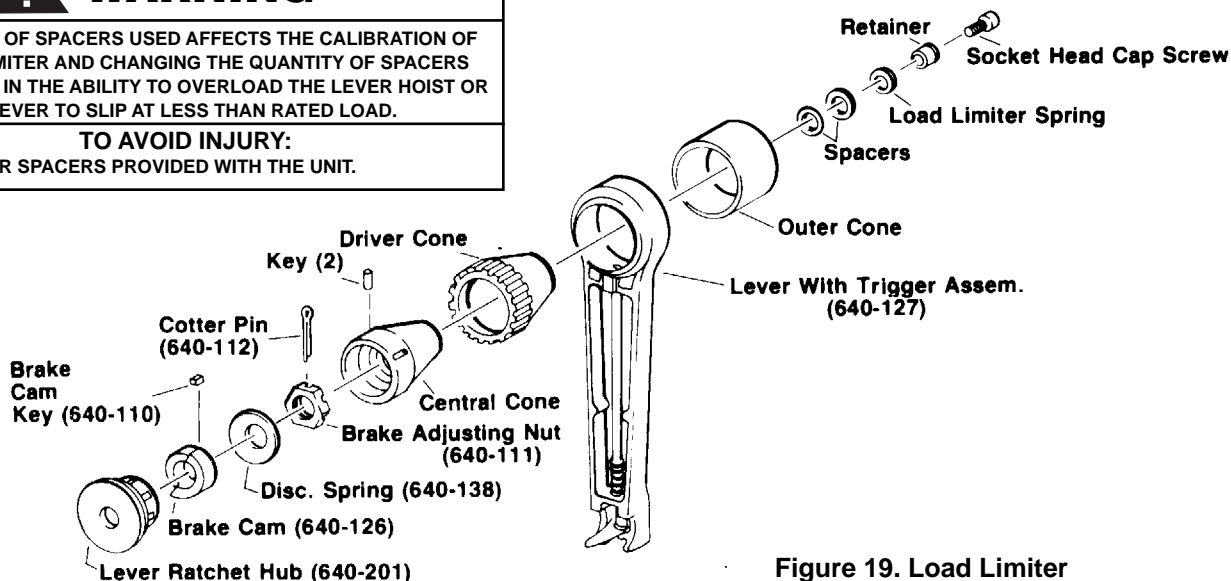

Figure 19. Load Limiter

Note: When ordering parts, always furnish rated load and serial number of hoist on which the parts are to be used.

For the location of the nearest Yale Authorized Hoist Parts Depot, see inside front cover.

LIMITATION OF WARRANTIES, REMEDIES AND DAMAGES

THE WARRANTY STATED BELOW IS GIVEN IN PLACE OF ALL OTHER WARRANTIES, EXPRESS OR IMPLIED, OF MERCHANTABILITY, FITNESS FOR A PARTICULAR PURPOSE, OR OTHERWISE, NO PROMISE OR AFFIRMATION OF FACT MADE BY ANY AGENT OR REPRESENTATIVE OF SELLER SHALL CONSTITUTE A WARRANTY BY SELLER OR GIVE RISE TO ANY LIABILITY OR OBLIGATION.

Seller warrants that on the date of delivery to carrier the goods are free from defects in workmanship and materials.

SELLER'S SOLE OBLIGATION IN THE EVENT OF BREACH OF WARRANTY OR CONTRACT OR FOR NEGLIGENCE OR OTHERWISE WITH RESPECT TO GOODS SOLD SHALL BE EXCLUSIVELY LIMITED TO REPAIR OR REPLACEMENT, F.O.B. SELLER'S POINT OF SHIPMENT, OF ANY PARTS WHICH SELLER DETERMINES TO HAVE BEEN DEFECTIVE or if Seller determines that such repair or replacement is not feasible, to a refund of the purchase price upon return of the goods to Seller.

Any action against Seller for breach of warranty, negligence or otherwise, must be commenced within one year after such cause of action occurs.

NO CLAIM AGAINST SELLER FOR ANY DEFECT IN THE GOODS SHALL BE VALID OR ENFORCEABLE UNLESS BUYER'S WRITTEN NOTICE THEREOF IS RECEIVED BY SELLER WITHIN ONE YEAR FROM THE DATE OF SHIPMENT. Seller shall not be liable for any damage, injury or loss arising out of the use of the goods if, prior to such damage, injury or loss, such goods are (1) damaged or misused following Seller's delivery to carrier; (2) not maintained, inspected, or used in compliance with applicable law and Seller's written instructions

and recommendations; or (3) installed, repaired, altered or modified without compliance with such law, instructions or recommendations.

UNDER NO CIRCUMSTANCES SHALL SELLER BE LIABLE FOR INCIDENTAL OR CONSEQUENTIAL DAMAGES AS THOSE TERMS ARE DEFINED IN SECTION 2-715 OF THE UNIFORM COMMERCIAL CODE.

INDEMNIFICATION AND SAFE OPERATION

Buyer shall comply with and require its employees to comply with directions set forth in instructions and manuals furnished by Seller and shall use and require its employees to follow such instructions and manuals and to use reasonable care in the use and maintenance of the goods. Buyer shall not remove or permit anyone to remove any warning or instruction signs on the goods. In the event of personal injury or damage to property or business arising from the use of the goods, Buyer shall within 48 hours thereafter give Seller written notice of such injury or damage. Buyer shall cooperate with Seller in investigating any such injury or damage and in the defense of any claims arising therefrom.

If Buyer fails to comply with this section or if any injury or damage is caused, in whole or in part, by Buyer's failure to comply with applicable federal or state safety requirements, Buyer shall indemnify and hold Seller harmless against any claims, loss or expense for injury or damage arising from the use of the goods.

 WARNING
ALTERATIONS OR MODIFICATIONS OF EQUIPMENT AND USE OF NON-FACTORY REPAIR PARTS CAN LEAD TO DANGEROUS OPERATION AND INJURY.
TO AVOID INJURY:
<ul style="list-style-type: none">• DO NOT ALTER OR MODIFY EQUIPMENT• DO USE ONLY FACTORY PROVIDED REPLACEMENT PARTS

For more information contact:
American Crane & Equipment Corp.
Authorized Distributor
Tel: 877-503-2972
Fax: 484-945-0430
sales@americancrane.com
www.americancrane.com

Yale[®]
HOISTS

414 WEST BROADWAY AVENUE
MUSKEGON, MICHIGAN 49443
1-800-999-6318 • 1-800-766-0223