

**OPERATING ,
MAINTENANCE &
PARTS MANUAL**

For more information contact:
American Crane & Equipment Corp.
Authorized Distributor
Tel: 877-503-2972
Fax: 484-945-0430
sales@americancrane.com
www.americancrane.com

**MANUALLY LEVER
OPERATED
CHAIN HOIST**

Yale® RS2 Lever Hoist



Capacities: 3/4, 1-1/2, 3 ton
(750, 1500, 3000 kg.)

Follow all instructions and warnings for inspecting, maintaining and operating this hoist.

The use of any hoist presents some risk of personal injury or property damage. That risk is greatly increased if proper instructions and warnings are not followed. Before using this hoist, each operator should become thoroughly familiar with all warnings, instructions and recommendations in this manual. **Retain this manual for future reference and use.**

Forward this manual to operator.
Failure to operate equipment as directed in manual may cause injury.

Before installing hoist, fill in the information below.

Model No. _____

Serial No. _____

Purchase Date _____

Rated Load _____

Yale® HOISTS

414 WEST BROADWAY AVENUE
MUSKEGON, MICHIGAN 49443

SAFETY PRECAUTIONS

Each Yale RS2 Manually Lever Operated Hoist is built in accordance with the specifications contained herein and at the time of manufacture complies with our interpretation of applicable sections of *ASME B30.21, *ANSI/ASME HST-3M and the Occupational Safety and Health Act-1970.

The safety laws for elevators and for dumbwaiters specify construction details that are not incorporated in Yale industrial hoists. We recommend the use of equipment that meets state and national safety codes for such use. Yale Hoists cannot be responsible for applications other than those for which Yale equipment is recommended.

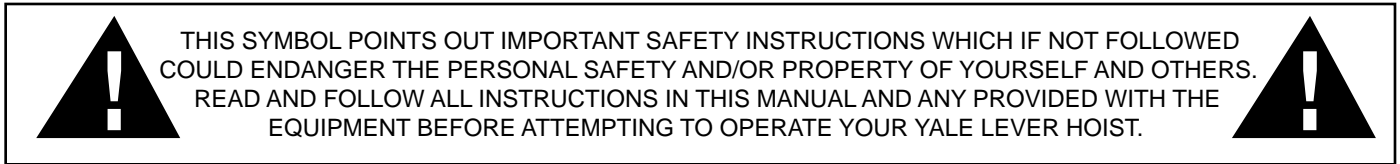

*Copies of these standards may be obtained from ASME Order Department, 22 Law Drive, Box 2300, Fairfield, NJ 07007-2300.



WARNING!

Improper operation of a hoist can create a potentially hazardous situation which, if not avoided, could result in death or serious injury. To avoid such a potentially hazardous situation, the operator shall:

1. NOT operate a malfunctioning or unusually performing hoist.
2. NOT operate the hoist until you have thoroughly read and understood this Operating, Maintenance and Parts Manual.
3. NOT operate a hoist which has been modified without the manufacturer's approval or certification to be in conformity with applicable OSHA regulations.
4. NOT lift or pull more than rated load for the hoist.
5. NOT use damaged hoist or hoist that is Not working properly.
6. NOT use hoist with twisted, kinked, damaged, or worn load chain.
7. NOT operate with any lever extension (cheater bar).
8. NOT attempt to "free-chain" the hoist while a load is applied.
9. NOT use the hoist to lift, support, or transport people.
10. NOT lift loads over people and make sure all personnel remain clear of the supported load.
11. NOT attempt to lengthen the load chain or repair damaged load chain.
12. Protect the hoist's load chain from weld splatter or other damaging contaminants.
13. NOT operate hoist when it is restricted from forming a straight line from hook to hook in the direction of loading.
14. NOT use load chain as a sling or wrap load chain around load.
15. NOT apply the load to the tip of the hook or to the hook latch.
16. NOT apply load unless load chain is properly seated in the chain wheel(s) or sprocket(s).
17. NOT apply load if bearing prevents equal loading on all load supporting chains.
18. NOT operate beyond the limits of the load chain travel.
19. NOT leave load supported by the hoist unattended unless specific precautions have been taken.
20. NOT allow the chain or hook to be used as an electrical or welding ground.
21. NOT allow the chain or hook to be touched by a live welding electrode.
22. NOT remove or obscure the warnings on the hoist.
23. NOT operate a hoist which has Not been securely attached to a suitable support.
24. NOT operate a hoist unless load slings or other approved single attachments are properly sized and seated in the hook saddle.

25. NOT lift loads that are Not balanced and that the holding action is Not secure, taking up slack carefully.
26. NOT operate a hoist unless all persons are and remain clear of the supported load.
27. Report malfunctions or unusual performances of a hoist, after it has been shut down until repaired.
28. NOT operate a hoist on which the safety placards or decals are missing or illegible.
29. Be familiar with operating controls, procedures, and warnings.



CAUTION!

Improper operation of a hoist can create a potentially hazardous situation which, if not avoided, could result in minor or moderate injury. To avoid such a potentially hazardous situation, the operator shall:

1. Maintain a firm footing or be otherwise secured when operating the hoist.
2. Check brake function by tensioning the hoist prior to each lift or pulling function.
3. Use hook latches. Latches are to retain slings, chains, etc. under slack conditions only.
4. Make sure the hook latches are closed and not supporting any parts of the load.
5. Make sure the load is free to move and will clear all obstructions.
6. Avoid swinging the load or hook.
7. Avoid lever "fly-back" by keeping a firm grip on the lever until operating stroke is completed and the lever is at rest.
8. Inspect the hoist regularly, replace damaged or worn parts, and keep appropriate records of maintenance.
9. Use the hoist manufacturer's recommended parts when repairing the unit.
10. Lubricate load chain per hoist manufacturer's recommendations.
11. NOT use the hoist load limiting or warning device to measure load.
12. NOT operate except with manual power.
13. NOT permit more than one operator to pull on lever at the same time. More than one operator is likely to cause hoist overload.
14. NOT allow your attention to be diverted from operating the hoist.
15. NOT allow the hoist to be subjected to sharp contact with other hoists, structures, or objects through misuse.
16. NOT adjust or repair the hoist unless qualified to perform such adjustments or repairs.

HOIST SAFETY IS UP TO YOU...



WARNING

-DO NOT APPLY MORE THAN RATED LOAD.

1

CHOOSE THE RIGHT HOIST FOR THE JOB...

Choose a Yale Lever Hoist with a capacity for the job. Know the capacities of your hoists and the weight of your loads. Then match them.

The application, the size and type of load, the attachments to be used and the period of use must also be taken into consideration in selecting the right hoist for the job.

Remember the hoist was designed to ease our burden and carelessness not only endangers the operator, but in many cases, a valuable load.



WARNING

- DO NOT OPERATE DAMAGED OR MALFUNCTIONING UNIT.
- DO NOT OPERATE WITH TWISTED, KINKED OR DAMAGED CHAIN.

2

INSPECT

All hoists should be visually inspected before use, in addition to regular, periodic maintenance inspections.

Inspect hoists for operational warning notices and legibility.

Deficiencies should be noted and brought to the attention of supervisors. Be sure defective hoists are tagged and taken out of service until repairs are made.



Under no circumstances should you operate a malfunctioning hoist.

Check chain for gouged, twisted, distorted links and foreign material. Do not operate hoists with twisted, kinked or damaged chain links.

Load chain should be properly lubricated.

Hooks that are bent, worn or whose openings are enlarged beyond normal throat opening should not be used. If latch does not engage throat opening of hook, hoist should be taken out of service.

Chains should be checked for deposits of foreign material which may be carried into the hoist mechanism.

Check brake for evidence of slippage under load.



WARNING

- DO NOT PULL AT AN ANGLE. BE SURE LEVER HOIST AND LOAD ARE IN A STRAIGHT LINE.
- DO NOT USE UNLESS FRAME AND CHAIN FORM A STRAIGHT LINE BETWEEN HOOKS.
- DO NOT USE IF FRAME IS IN CONTACT WITH ANY OBJECT.
- DO NOT USE LOAD CHAIN AS A SLING.
- DO NOT USE AN EXTENSION ON THE LEVER.

3

USE HOIST PROPERLY

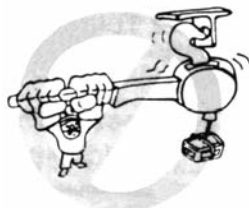

Be sure the hoist is solidly held in the uppermost part of the support hook arc.



Be sure the hoist and load are in a straight line. Do not use unless frame and chain form a straight line between hooks.



Be sure load is hooked securely. Do not tip load the hook. Do not load hook latch. Hook latch is to prevent detachment of load under slack chain conditions only.



Do not operate with hoist frame resting against any object. Apply the load gently. Do not jerk it.



Never use an extension on the lever! You're dangerously overloading the hoist if you exceed the rated lever pull or if you have to use a lever extension to lift or pull a load.



WARNING

- DO NOT LIFT PEOPLE OR LOADS OVER PEOPLE.

4

PRACTICE CAUTION ALWAYS

Do not lift co-workers with a Yale Lever Hoist.

Make sure everyone is clear of the load when you apply tension.

Do not remove or obscure operational warning notices.

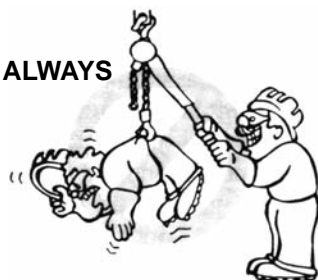

5

OPERATOR SERVICE

CLEANING: Lever Hoists should be kept clean and free of dust, dirt, moisture, etc., which will in any way affect the operation or safety of the equipment.

LUBRICATION: Chain should be properly lubricated.

AFTER REPAIRS: Carefully operate the hoist before returning it to full service.



VIOLATION OF ANY OF THESE WARNINGS LISTED MAY RESULT SERIOUS PERSONAL INJURY TO THE OPERATOR OR NEARBY PERSONNEL BY RELEASED LOAD OR BROKEN HOIST COMPONENTS.

SPECIFICATIONS

The Yale RS2 Lever Hoist is a highly versatile manually lever operated chain hoist that can be used to efficiently pull, lift, drag or stretch. Standard features of the hoist include:

- Alloy steel liftwheel to reduce chain wear.
- Hoistaloy® load chain for long and dependable service.
- Grease lubricated, hardened, alloy steel gears for smooth operation.
- Forged steel upper and lower latch type hooks.
- Patented, free-chaining mechanism for quick and easy attachment to the load.
- Lightweight, aluminum frame, covers and lever.
- Ball or needle bearings at rotating points.
- Compact, yet rugged, design provides minimum headroom and long trouble free service.
- Sealed automatic brake with two holding pawls for positive load control.
- Short lever (12 inches-305 mm long on 3/4 ton unit, 16-3/4 inches-425 mm long on 1-1/2 and 3 ton units) for operation in close quarters.
- Rocking and swivel upper hook (3/4 and 1-1/2 ton units)
- Backed by Yale's life-time warranty.

YALE REPAIR/REPLACEMENT POLICY

All Yale RS2 Lever Hoists are inspected and performance tested prior to shipment. If any properly maintained hoist develops a performance problem, due to a material or workmanship defect, as verified by Yale, repair or replacement of the unit will be made to the original purchaser without charge. This repair/replacement policy applies only to hoists installed, maintained and operated as outlined in this manual, and specifically excludes hoists subject to normal wear, abuse, improper installation, improper or inadequate maintenance, hostile environmental effects and unauthorized repairs/modifications.

We reserve the right to change materials or design if, in our opinion, such changes will improve our product. Abuse, repair by an unauthorized person, or use of non-Yale replacement parts voids the guarantee and could lead to dangerous operation. For full Terms of Sale, see Sales Order Acknowledgment. Also, refer to the back cover for Limitations of Warranties, Remedies and Damages, and Indemnification and Safe Operation.



WARNING

ALTERATIONS OR MODIFICATIONS OF EQUIPMENT AND USE OF NON-YALE REPAIR PARTS CAN LEAD TO DANGEROUS OPERATION AND INJURY.

TO AVOID INJURY:

- DO NOT ALTER OR MODIFY EQUIPMENT.
- DO USE ONLY YALE PROVIDED REPLACEMENT PARTS.

OPTIONS

Load Limiter®

The Load Limited is a friction device that is designed and factory calibrated to prevent lifting excessive overloads. An excessive overload is indicated by lever movement without corresponding movement of the lower hook or load when the hoist is operated in the up direction. Should this occur, operate the lever in the down direction to remove the overload. Reducing the load to rated capacity or less will automatically restore normal operation. The Load Limiter can be ordered as part of a new lever hoist or in kit form that can be added to units now in service.

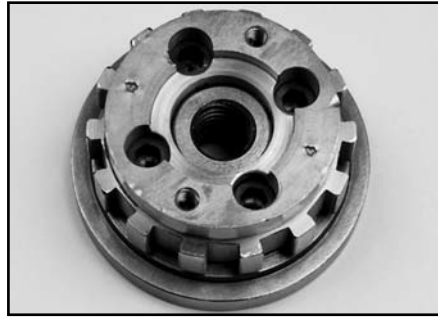

Latchlok® Hooks

Latchlok hooks are available to replace the standard latch type hooks. The unique design of the Latchlok hook assures that it will stay locked until the operator releases it by depressing the release button. It will not open accidentally—even if the load chain goes slack. Once opened, it can be shut with one hand or by the weight of the load when it is lifted. Latchlok hooks can be supplied with the hoist or it can be provided in kit form for lever hoists already in service.



Anchor Sling (for 3/4 and 1-1/2 ton units only)

Anchor Sling is an upper hook extender that simplifies attachment when application or space limitation makes it impossible to pull in a straight line from hook to hook. A swiveling hook block is securely anchored to the housing and the upper hook swivels through a full 360°. Anchor Sling may be ordered as a feature of your new hoist or in kit form for simple installation on units now in use.

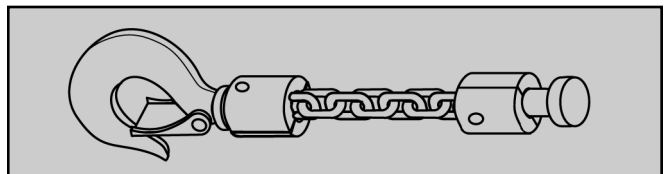

INSTALLATION

UNPACKING

After removing the hoist from the carton, check it for damage that may have occurred during shipment. If there is damage, refer to the packing slip envelope for claims procedure.

INSTALLATION

The RS2 Lever Hoist is designed for operation at ambient temperatures of 0° to 100° F (-17° to 38° C). It can be used in any position for pulling a load at an angle, horizontal pulling or vertical lifting, provided it is rigged to pull in a straight line from hook to hook and the frame is free to swivel on the upper hook.



WARNING

IF THE UNIT IS NOT RIGGED IN A STRAIGHT LINE, HOOK TO HOOK MANNER, AND IF THE FRAME IS NOT FREE TO SWIVEL, LEVER PULL MAY BREAK FRAME AND CAUSE PHYSICAL INJURY AND LOSS OF LOAD.

TO AVOID INJURY:
RIG THE UNIT IN A STRAIGHT LINE HOOK TO HOOK MANNER AND KEEP FRAME FREE TO SWIVEL - SEE FIGURE ON PAGE 3.

Regardless of how the hoist is used, make sure that the upper hook is firmly attached to a support or anchor that has sufficient strength to hold several times the rated load of the hoist.

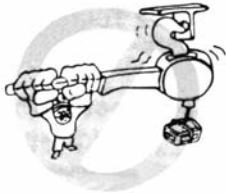

Using the upper hook, attach the hoist to support.

Be sure hoist is solidly held in the uppermost part of the hook arc and the latch is tightly against the hook tip.



WARNING

ATTACHING THE HOIST FROM AN INADEQUATE SUPPORT MAY ALLOW THE HOIST AND LOAD TO FALL AND CAUSE INJURY AND/OR PROPERTY DAMAGE.

TO AVOID INJURY:
MAKE SURE THE STRUCTURE HAS SUFFICIENT STRENGTH TO HOLD SEVERAL TIMES THE HOIST AND ITS RATED LOAD.

OPERATION



WARNING

IF NOT USED AS DIRECTED, HOIST MAY CAUSE INJURY.

TO AVOID INJURY:
USE ONLY AS DIRECTED BELOW. READ ALL INSTRUCTIONS BEFORE OPERATING THE RS2 LEVER HOIST.

GENERAL

- The hoist must be kept clean to assure proper operation. Before use, check to be sure the load chain is clean, that there is no foreign material in the liftwheel area and that the lever operates freely.
- Do not load beyond the rated capacity. Overload can cause immediate failure or cause damage resulting in future failure, even at less than rated capacity.
- Do not use this hoist or any other material handling equipment for lifting or moving people, or lifting loads over people.
- Stand clear of all loads and warn other people of your intention to move a load in their area.
- Do not leave a load on the unit unattended.
- Read warnings and instructions on the lever before each use.
- Do not hold the load chain while operating the hoist. Should the hoist not operate properly, serious injury may occur.

H. Never operate the hoist when flammable materials or vapors are present. Contact between metal parts may produce sparks that can cause a fire or explosion.

I. **STAY ALERT!** Watch what you are doing and use common sense. Do not use the hoist when you are tired, distracted or under the influence of drugs, alcohol or medication causing diminished control.



WARNING

MALFUNCTION OF UNIT, RIGGING SLIP OR LOSS OF FOOTING MAY CAUSE USER TO SLIP RESULTING IN INJURY.

TO AVOID INJURY:
ALWAYS HAVE A FIRM AND SECURE FOOTING WHEN USING THE RS2 LEVER HOIST.

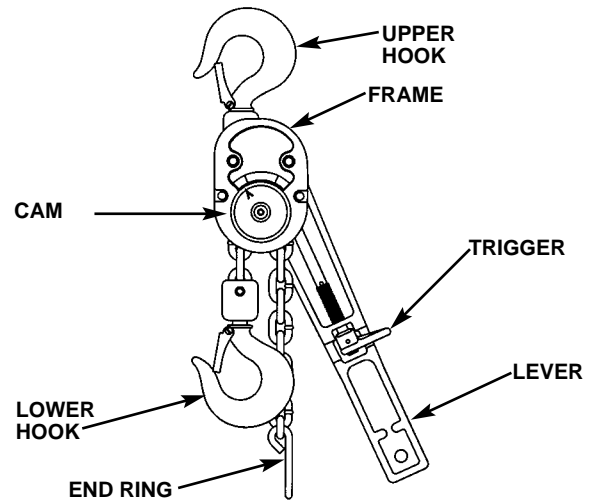

FREE-CHAINING



WARNING

FAILURE TO PROPERLY USE THE FREE-CHAIN MECHANISM MAY CAUSE INJURY AND/OR PROPERTY DAMAGE.

TO AVOID INJURY:
USE THE FREE-CHAIN MECHANISM AS DIRECTED BELOW.

In this mode of operation, the gearing is disengaged to allow the chain to be easily pulled through the hoist by hand, for quick attachment to the load.

To free-chain the RS2 Lever Hoist:

- Make sure there is no load on the lower hook.
- Turn the lever trigger 1/4 turn from "UP" or "DN".

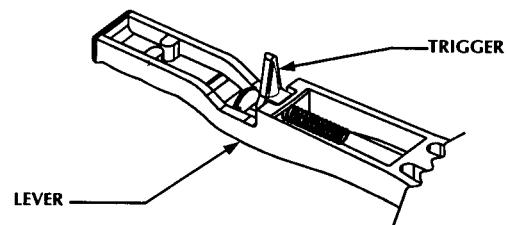

- Rotate the cam knob 1/4 turn clockwise (to right) from "OPERATE" to "FREE-CHAIN". A "click" will be heard or felt and the cam cannot be rotated further in the clockwise position.

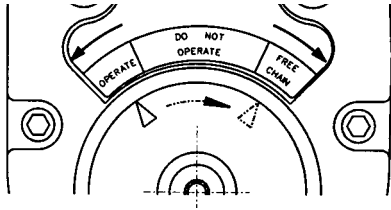

4. Pull on hook side and loose end side of load chain to make sure chain feeds freely into and out of the hoist.

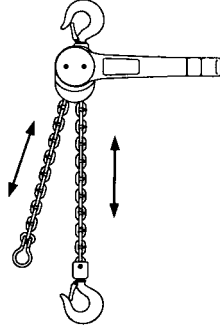

5. Grasp unit by frame or upper hook and pull on end ring or lower hook to pull the chain through hoist to the length required to attach lower hook to load. Pull on end ring to take-up slack in chain and **THEN LET GO OF END RING**.
6. Rotate the cam counterclockwise (to left) until the arrow points to "operate".

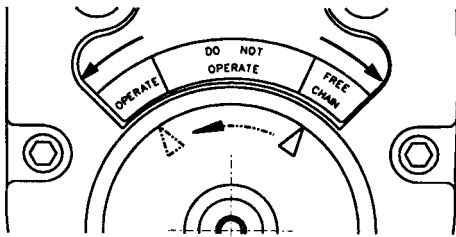

7. Pull sharply on the loose end of chain and **THEN LET GO OF CHAIN**. Pull sharply on the lower hook side of chain, to make sure gearing is fully engaged.

 WARNING
FAILURE TO FULLY ENGAGE THE GEARING WILL ALLOW LOAD TO RELEASE AND THUS CAUSE INJURY
TO AVOID INJURY:
AFTER ROTATING CAM KNOB TO "OPERATE", PULL EACH CHAIN SHARPLY TO RE-ENGAGE GEARING AS DIRECTED ABOVE.

8. The hoist is now ready for operation. Move trigger to "UP" position and operate lever in up and down motion to shorten the distance between hooks and thus pull or lift load. Only move the load enough to slightly load the hoist. Check free-play of cam knob. The arrow tip should not move more than 3/16 inch (4.7mm). If movement is greater than this, move trigger to "DN" position and operate the lever to remove the load. Repeat step 7 and if the free-play is still more than 3/16 inch (4.7mm), the hoist should be disassembled to check for damaged or worn parts. Do not take up the load chain to the point where the end ring or lower hook block becomes jammed against the frame.

ATTACHING TO LOAD

Attach the lower hook to the load so that it is seated in the bowl of the hook and is not bearing against the tip of the hook, and the latch is tight against the hook tip.

 WARNING
ALLOWING THE LOAD TO BEAR AGAINST THE HOOK LATCH AND/OR HOOK TIP CAN RESULT IN LOSS OF LOAD.
TO AVOID INJURY:
DO NOT ALLOW THE LOAD TO BEAR AGAINST THE HOOK LATCH AND/OR HOOK TIP. APPLY LOAD TO HOOK BOWL OR SADDLE ONLY.

Do not wrap the load chain around the load and hook onto itself as a choker chain sling or bring the load in contact with the hoist. Doing this will result in the loss of the swivel effect of the hook which could cause twisted chain and a jammed liftwheel. Also, the chain may be damaged at the hook. Make sure the upper and lower hooks are in a straight line and the frame is free to swivel on the upper hook. If the proposed use prevents straight line attachment, use an Anchor Sling (see page 1) or a chain sling to obtain a straight line pull.

 WARNING
IF THE UNIT IS NOT RIGGED IN A STRAIGHT LINE HOOK TO HOOK MANNER, AND IF THE FRAME IS NOT FREE TO SWIVEL, LEVER PULL MAY BREAK FRAME AND CAUSE PHYSICAL INJURY AND LOSS OF LOAD.
TO AVOID INJURY:
RIG THE UNIT IN A STRAIGHT LINE HOOK TO HOOK MANNER AND KEEP FRAME FREE TO SWIVEL - SEE BELOW.

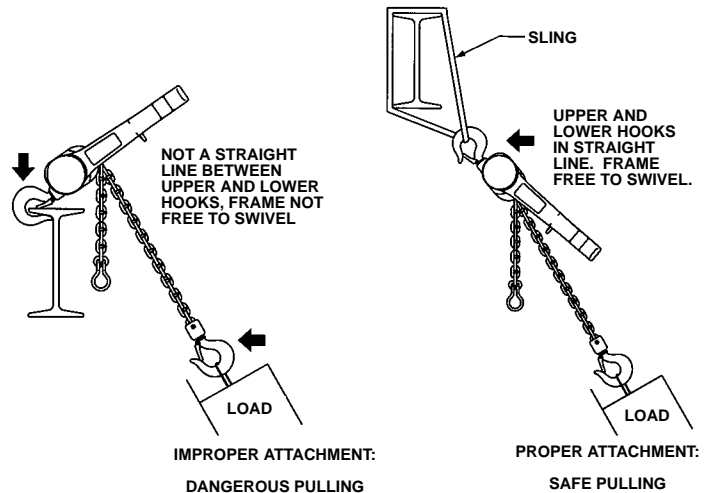

TO PULL OR LIFT LOAD

Move lever trigger to "UP" position. Operate lever in up and down motion to shorten the distance between hooks and thus pull or lift the load. When pulling or lifting move the load only enough to slightly

load the unit, then check to be sure that the attachments to the hooks and load are firmly seated. Continue movement only after you are assured the load is free of all obstructions.

The hoist has been designed for hand powered operation only. Do not use an extension on the lever. Lever pulls of 45 pounds (21kg.) on the 3/4 ton unit, 55 pounds (25kg.) on the 1-1/2 ton unit and 62 pounds (28kg.) on the 3 ton unit will result in rated capacity on the unit. Any greater pull is an indication of either an overload or an incorrectly maintained unit.

TO LOOSEN OR LOWER LOAD

 <h2 style="margin: 0;">WARNING</h2>
<p>POWER OPERATION MAY CAUSE STRUCTURAL DAMAGE OR PREMATURE WEAR THAT IN TURN MAY CAUSE A PART TO BREAK AND ALLOW THE LOAD TO FALL.</p>
<p>TO AVOID INJURY: OPERATE THE RS2 LEVER HOIST USING HAND POWER ONLY!</p>

Move lever trigger to “DN” position. Again, operate lever in an up and down motion to increase the distance between hooks and thus loosen or lower the load.

Note that the cam is NOT changed when changing from “up” to “down” or from “down” to “up” operation.

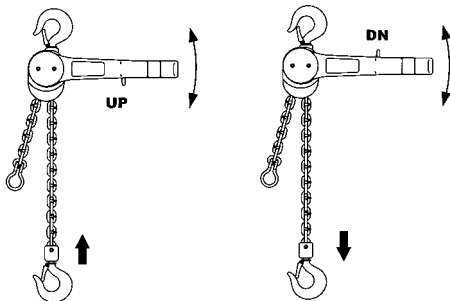

 <h2 style="margin: 0;">WARNING</h2>
<p>TURNING THE CAM WITH A LOAD ATTACHED WILL ALLOW THE LOAD TO RELEASE AND MAY CAUSE INJURY.</p>
<p>TO AVOID INJURY: NEVER TURN THE CAM WHEN THE HOIST IS UNDER LOAD.</p>

INSPECT THE RS2 LEVER HOIST

Inspect the RS2 before each use and at specified intervals as directed in the inspection section (see next column).

LOAD LIMITER®

The operation of a RS2 Lever Hoist equipped with a Load Limiter is the same as described above. In fact, as long as you are pulling or lifting loads that are within the rated capacity of the hoist, the Load Limiter will not function and you will not notice any difference in operation. However, if attempting to pull or lift load that is approximately 20% greater than rated capacity, the Load Limiter will function.

As a result, the lever will move but, there will be no corresponding movement of the lower hook or load, when the unit is operated in the “up” direction. Should this occur, immediately move the trigger to the “DN” position and operate the lever until the overload is set down and removed from the unit. Reducing the load to rated capacity or less will automatically return the hoist to normal operation.

CAUTION: THE LOAD LIMITER IS SUBJECT TO OVERHEATING AND WEAR WHEN EXCESSIVELY OPERATED. FOR THIS REASON, WHEN AN OVERLOAD IS DETECTED, THE EXCESS LOAD MUST BE REMOVED AS QUICKLY AS POSSIBLE WITHOUT CONTINUED OPERATION OF THE LEVER.

Under certain conditions, such as applying an overload and removing it by external means, the brake may become “locked”. This results in not being able to operate the unit in the “down” direction. Should this occur, move the trigger to the “DN” position and give the lever a sharp pull and then additional strokes to lower the load and remove tension from the unit.

 <h2 style="margin: 0;">WARNING - TO AVOID INJURY:</h2>
<p>Use as directed above. Failure to do so may cause injury to you or others.</p> <ol style="list-style-type: none"> 1. Do not exceed capacity shown on frame or lower hook block. 2. Do not use to lift people or loads over people. 3. Do not use unless the hoist’s frame and chain form a straight line between hooks. 4. Do not use if the frame is in contact with any object. 5. Do not use if the unit is damaged or malfunctions. 6. Do not use extension on lever. Use hand power only. 7. Do not use if chain is twisted, kinked or damaged.

MAINTENANCE

INSPECTION

To maintain continuous and satisfactory operation, a regular periodic inspection procedure must be initiated so that worn, damaged and missing parts can be replaced before the unit becomes unsafe. The frequency of inspection must be determined by the individual application.

The following list gives an inspection procedure for normal usage under normal conditions.

When the unit is subjected to heavy usage or dusty, gritty, moist or corrosive atmospheric conditions, shorter time periods must be assigned. Inspection must be made of all parts for unusual wear, corrosion or damage, in addition to those specifically mentioned in the schedule on page 5. Make certain that the unit is complete and contains all parts including hook latches and end ring.

Any parts that are deemed unserviceable must be replaced with new parts before the unit is returned to service. It is very important that the unserviceable parts be destroyed and properly disposed of to prevent their possible future use as a repair item. Use only Yale Hoist supplied repair parts as other parts may look the same but may not be to proper specifications.

Inspection of hoists is divided into two general classifications designated as "frequent" and "periodic".

Frequent Inspections

These inspections are by the operator or other designated personnel. Frequent inspections are to be performed daily or prior to each use and they are to include the following:

- A. Check for free movement of the lever, trigger and cam.
- B. Operate hoist with no load and check for visual signs or abnormal noises that could indicate a potential problem.
- C. Check brake for evidence of slippage.
- D. Check chain for lubrication, wear damaged links or foreign material (see page 6).
- E. Check hooks for damage, cracks, twist, latch engagement and latch operation (see below).
- F. Check lever for bends, cracks and damage.
- G. Check support or anchor for damage.

Any deficiencies noted during the frequent inspections must be corrected before using the hoist.

Periodic Inspections

These are visual inspections by an appointed person who records conditions to provide a basis for a continuing evaluation of the hoist. Periodic inspections are to be performed semi-annually and they should include the following:

- A. All items listed under frequent inspections.
- B. Evidence of loose screws.
- C. Evidence of worn, corroded, cracked or distorted upper and lower hook blocks, frame, end ring, hook block screws, covers, lever, suspension bolt, gears, bearings, pawls, pawl springs, cam, cam pins, lever cover, free-chaining spring, ratchet hub, stripper, Load Limiter (if equipped with same), ratchet and hoist hanger.
- D. Evidence of worn, glazed or oil contaminated friction discs. Friction discs should be replaced if their thickness is less than .075 inch (2 mm).
- E. Warning label for legibility.

NOTE: To perform some of the periodic inspections, it is necessary to partially disassemble the hoist. Refer to Disassembly-Assembly starting on page 7. Also, the external conditions may show the need for more detailed inspection which, in turn, may require the use of non-destructive type testing.

Any deficiencies noted during the periodic inspection must be corrected before using the hoist.

Hook Inspection

Hooks damaged from chemicals, deformations, or cracks, or that have more than a 10° twist from the plane of the unbent hook or excessive opening or seat wear must be replaced.

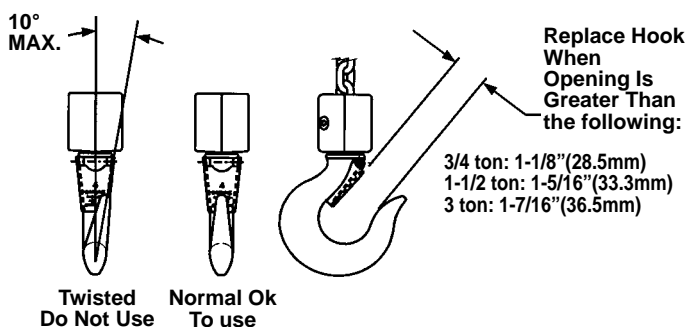

Any hook that is twisted or has excessive throat opening indicates abuse or overloading of the unit. Other load-sustaining components of the hoist should be inspected for damage.

On latch type hooks, check to make sure that the latch is not damaged or bent and that it operates properly with sufficient spring pressure to keep the latch tightly against the tip of the hook and allow the latch to spring back to the tip when released. If the latch does not operate properly, it must be replaced. See previous illustration to determine when the hook must be replaced.

Replace Hook If Opening Is Greater Than 1-1/8" (28.5 mm) on 3/4 and 1-1/2 ton units or 1-15/16" (49.2mm) on 3 ton unit.

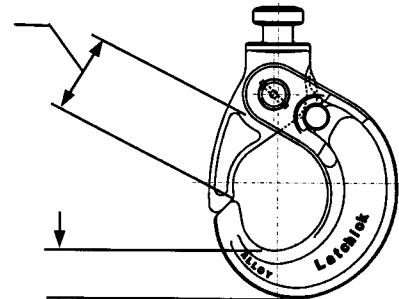

Replace Hook If Seat Is Less Than 21/32" (16.7 mm) on 3/4 and 1-1/2 ton units or 1-1/8" (28.5mm) on 3 ton unit.

On Latchlok type hooks, measure seat wear and throat opening as shown above and replace hook if measurements indicate the need to do same.

LOAD CHAIN

Chain should feed smoothly into and away from the hoist. If chain binds, jumps or is noisy, first clean and lubricate it (see below). If trouble persists, inspect chain and mating parts for wear, distortion or other damage.

Chain Inspection

First clean chain with a non-caustic/non-acid type solvent and make a link by link inspection for nicks, gouges, twisted links, weld spatter, corrosion pits, striations (minute parallel lines), cracks in weld areas, wear and stretching. Chain with any one of these defects must be replaced.

Slack the portion of the chain that normally passes over the .250 (6.3 mm) for 3/4 ton unit

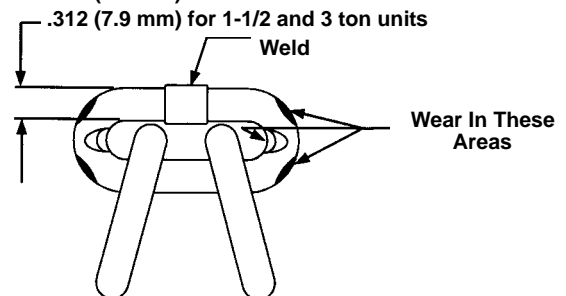

liftwheel. Examine the interlink area for the point of maximum wear (polishing). Measure and record the stock diameter at this point of the link. Then measure stock diameter in the same area on a link that does not pass over the liftwheel (use the link adjacent to the end ring for this purpose). Compare these two measurements. If the stock diameter of the worn link is 0.010 inches (0.254mm), or more, less than the stock diameter of the unworn link, the chain must be replaced.

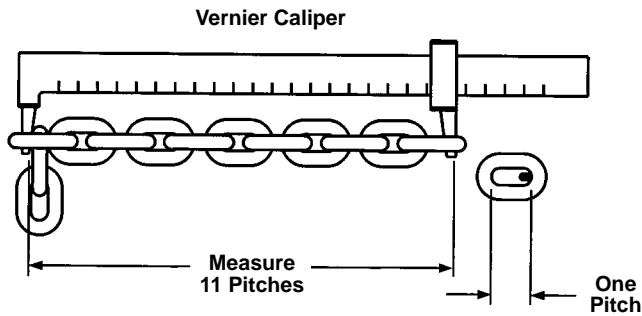

Also check chain for stretch using a vernier caliper as shown above. Select an unused, unstretched section of chain (usually at the loose end) and measure and record the length over 11 chain links (pitches). Measure and record the same length on a worn section of chain. Obtain the amount of stretch and wear by subtracting the measurement of the unworn section from the measurement of the worn section. If the result (amount of stretch and wear) is greater than 0.145 inch (3.7 mm), the chain must be replaced.

 WARNING
<p>USING OTHER THAN YALE SUPPLIED LOAD CHAIN MAY CAUSE THE CHAIN TO JAM IN THE HOIST AND/OR ALLOW THE CHAIN TO BREAK AND THE LOAD TO DROP.</p>
<p>TO AVOID INJURY:</p> <p>DUE TO SIZE REQUIREMENTS AND PHYSICAL PROPERTIES, USE ONLY HOISTALOY® LOAD CHAIN IN THE RS2 LEVER HOIST.</p>

Use only a "Knife-Edge" caliper to eliminate possibility of false reading by not measuring full pitch length. Note that worn chain can be an indication of worn hoist components. For this reason, the hoist's frame, stripper, and liftwheel should be examined for wear and replaced as necessary when replacing worn chain.

Also, the load chain is specially heat treated and hardened and should never be repaired.

IMPORTANT:

Do not use replaced chain for other purposes such as lifting or pulling. Load chain may break suddenly without visual deformation. For this reason, cut replaced chain into short lengths to prevent use after disposal.

Chain Lubrication

A small amount of lubricant will greatly increase the life of load chain. Do not allow the chain to run dry. Keep it clean and lubricate at regular intervals with Lubriplate® Bar and Chain Oil 10-R (Fiske Bros. Refining Co.) or equal lubricant. Normally, weekly cleaning and lubrication is satisfactory, but under hot and dirty conditions, it may be necessary to clean the chain at least once a day and lubricate it several times between cleanings.

 WARNING
<p>USED MOTOR OILS MAY CONTAIN KNOWN CARCINOGENIC MATERIALS.</p>
<p>TO AVOID INJURY:</p> <p>NEVER USE USED MOTOR OILS AS A CHAIN LUBRICANT. ONLY USE LUBRIPLATE® BAR AND CHAIN OIL 10-R AS A LUBRICANT FOR THE LOAD CHAIN.</p>

When lubricating the chain, apply sufficient lubricant to obtain natural run-off and full coverage, especially in the interlink area.

LUBRICATION

Refer to Exploded View and Parts List pages 10 thru 13.

 WARNING
<p>THE LUBRICANTS USED IN AND RECOMMENDED FOR THE RS2 LEVER HOIST MAY CONTAIN HAZARDOUS MATERIALS THAT MANDATE SPECIFIC HANDLING AND DISPOSAL PROCEDURES.</p>
<p>TO AVOID CONTACT AND CONTAMINATION:</p> <p>HANDLE AND DISPOSE OF LUBRICANTS ONLY AS DIRECTED IN APPLICABLE MATERIAL SAFETY DATA SHEETS AND IN ACCORDANCE WITH APPLICABLE LOCAL, STATE, AND FEDERAL REGULATIONS.</p>

NOTE: To assure extra long life and top performance, be sure to lubricate the various parts of the hoist using the recommended lubricants. These lubricants may be purchased from Yale. Refer to page 13 for information on ordering the lubricants.

Except for lubricating the load chain frequently, the hoist requires no additional lubrication, unless it has been disassembled for cleaning, inspection and/or repairs. If the unit has been disassembled, remove the "old" lubricant from the parts and apply new lubricants as follows:

- A. A light coat of Texaco Novatex #2, or equal, grease to:
 - Needle bearings in gear cover (673-5) and frame (673-2).
 - Inside of pinion bushing (673-25).
 - Outside surface of cam pins (673-47).
 - Inside diameter and the cam pin slots in cam (673-18).
 - Outside surface of suspension bolt (673-48).
 - Spline of liftwheel (673-10).
 - Outside surface of locking pins (673-78).
- B. A light coat of Lubrico M-32 (Master Lubricant Co.) or equal grease to inside diameter of lever head (673-39).
- C. A light coat of Moly-Duolube #67 (Hercules Packing Co.) or equal dry film lubricant to threads and spline of pinion (673-9).
- D. A light coat of a *graphite/grease mixture to knob of upper and lower hooks (673-35) and bearing journals of 3 ton lower sheave (673-70).
- E. 1/2 oz. on 3/4 ton unit and 2/3 oz. on 1-1/2 and 3 ton units of Texaco Novatex #2, or equal grease to pinion (673-9) teeth, liftwheel gear (673-11) teeth and in gear cavity of frame (673-2).
- F. A light coat of a **graphite/oil mixture to tip of lever plunger (673-46) for approximately 1 inch (25.4mm) and threaded end (up to including the spline) of the pinion shaft (673-9).
- G. See above for lubricating load chain.

* graphite/grease mixture consists of 1 lb. (.46 Kg.) Superior Graphite Co. #590 flake graphite and 2 lb (.92 Kg.) of Master Lubricant Co. Lubricko M-32 grease.

**graphite/oil mixture consists of 1 oz. of Superior Graphite Co. #590 flake graphite and 1 qt. (946 ml) of Acheson Industries #DAG-154RFU oil.



WARNING

USING ANY GREASE OR LUBRICANT ON THE BRAKING SURFACES WILL CAUSE BRAKE SLIPPAGE AND LOSS OF LOAD CONTROL WHICH MAY RESULT IN INJURY AND/OR PROPERTY DAMAGE.

TO AVOID INJURY:

DO NOT USE ANY GREASE OR LUBRICANT ON BRAKING SURFACES. THE BRAKE IS DESIGNED

When lubricating parts adjacent to the brake, DO NOT use an excessive amount of lubricant which could seep onto the brake surfaces.

EXTERIOR FINISH

The exterior surface of the RS2 Lever Hoist has a durable, scratch resistant baked powder coating. Normally, the exterior surfaces can be cleaned by wiping with a cloth. However, if the finish is damaged, compatible touch-up paint can be purchased from Yale. Refer to page 13 for information on ordering paint.

PREVENTATIVE MAINTENANCE

A preventative maintenance program should be established to prolong the useful life of the hoist and maintain its reliability and continued safe use. The program should include frequent and periodic inspections (see page 5) with particular attention paid to lubrication of various components using the recommended lubricants (see Lubrication section for lubricating load chain and other parts).

RECOMMENDED SPARE PARTS

To insure continued operation, it is recommended that two friction discs (Key No. 673-13) be kept on hand at all times to replace friction discs that are worn, glazed or contaminated. Refer to page 12 for ordering information).

DISASSEMBLY

When disassembling and assembling the RS2 Lever Hoist, refer to the exploded view and parts list on pages 10 thru 13. These show the proper relationship of the parts, part names and the required quantities of the parts. In addition, please observe the following:

- The liftwheel gear (673-11) is under spring pressure and may spring out when the gear cover (673-5) is removed.
- Needle bearings are pressed into the gear cover (673-5) and frame (673-2). Unless they are to be replaced, do not attempt to remove these bearings.
- If so equipped, do not attempt to disassemble the Load Limiter (673-59). The Load Limiter is calibrated by Yale, and no attempt should be made to recalibrate the device.

If it is not functioning properly, the entire Load Limiter must be replaced.

- Refer to page 8 for removal and installation of load chain.
- The brake cover (673-8) includes a rubber seal and care should be taken to make sure it is not cut or damaged.

ASSEMBLY

When reassembling the unit, lubricate the various parts as specified on page 6 and observe the following:

- Maintain the proper relationship of the lever plunger (673-46) tip and the trigger (673-43) as shown above.

- Assemble pinion washer (673-26) and then bushing

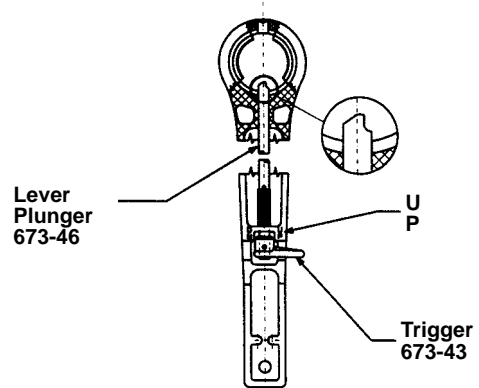

- Place liftwheel bearing (673-1) on liftwheel (673-10) and slide this assembly into frame (673-2).
- Place the large end of the free-chain spring (673-20) in the recess of the liftwheel gear (673-11) and slide the gear onto the liftwheel (673-10) spline-spring end first.
- Assemble snap ring (673-33) to suspension bolt (673-48). Assemble upper hook (673-35) and hook blocks

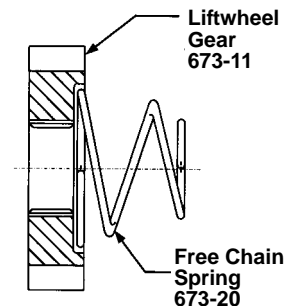

- Place this assembly in recess on top of frame (673-2) and secure by sliding the suspension bolt through holes in frame and hook block. Snap ring on suspension bolt must be on gear side of frame.
- Push on liftwheel gear to compress the spring and attach the gear cover (673-5) to the frame (673-2)
- Insert the cam pins (673-47) - ROUND END OUT - in the holes above and below boss on gear cover (673-5).
- Assemble the cam (673-18) to the gear cover (673-5) so that the arrow is pointing towards "operate".

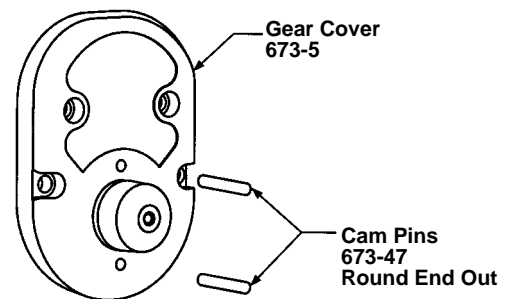

- Secure the cam using the cam washer (673-60) and

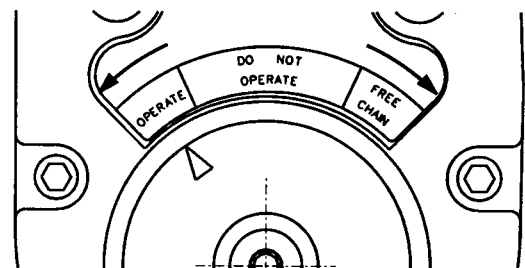

screw (673-29).

- J. Assemble pawls (673-19) to pawl shafts (673-22) and secure with snap rings (673-32). Place pawl springs (673-21) on pawl shafts and insert these assemblies into frame (673-2).
- K. Slide friction hub (673-12) onto pinion (673-9) and place one friction disc (673-13) on top of friction hub.

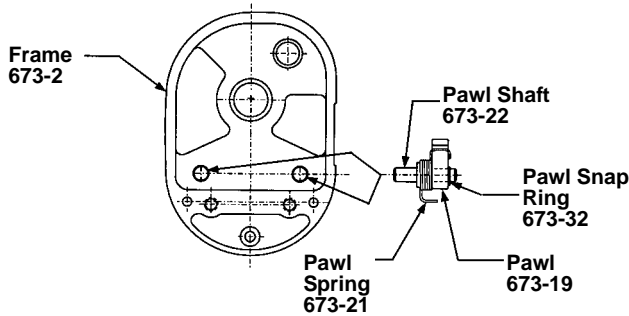

Assemble ratchet bushing (673-24) to ratchet (673-23). Spring apart pawls and slide ratchet/bushing assembly on friction hub as shown below.

- L. To assemble and adjust the brake, place the second friction disc (673-13) on top of the ratchet. Thread the

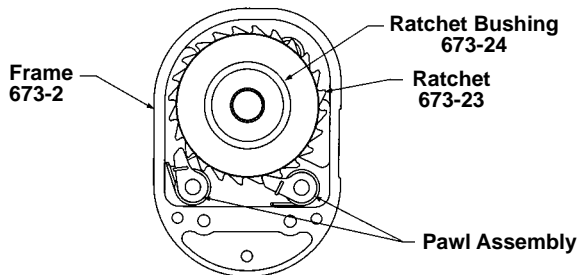

ratchet hub (673-14) or Load Limiter (673-59) onto the pinion (673-9). Insert the two locking pins (673-78) into the holes of the ratchet hub or Load Limiter. Holding the pinion steady, rotate the ratchet hub or Load Limiter from the stop in the full clockwise position to the stop in the full counterclockwise position. From stop to stop there should be 10 to 45° of rotation. If the rotation does not fall within this range, remove the locking pins, ratchet hub or Load Limiter, pawl assemblies (see step J), friction discs, ratchet and ratchet bushing. Slide the friction hub partially off of the pinion until the splines disengage. Rotate the friction hub slightly clockwise if the rotation is more than 45° or counterclockwise if the rotation is less than 10°. Repeat steps 1-4 until the rotation from stop to stop is 10 to 45°. **Note:** The ratchet hub or Load Limiter can be started onto the thread of the pinion in one of four positions. Each time the ratchet hub or Load Limiter is threaded onto the pinion, maintain the same orientation. Install the pawl assemblies per step K.

- M. Assemble the snap ring (673-31) to the stripper pin (673-34). Slide the stripper (673-15) into the recess in the bottom of the frame and secure by sliding the stripper pin thru the holes in the frame and stripper.
- N. Assemble brake cover (673-8) to frame.
- O. Assemble the lever assembly (step A) to ratchet hub (673-14) or Load Limiter (673-59) and secure by attaching the lever cover (673-17) to the ratchet hub or Load Limiter.
- P. Install load chain (673-52) - see removal and installation of load chain.
- Q. After assembly, test the unit as indicated on page 9.

REMOVAL OF LOAD CHAIN

- A. Remove the lower hook block assembly from the load chain on the 3/4 and 1-1/2 ton units. On the 3 ton unit, disengage the load chain from the hoist hanger (673-75) by removing the dead end pin (673-76).

- B. Put unit in free-chaining - see page 2
- C. Pull on the end ring (673-53) and pull the chain out of the hoist (and out of the lower hook block on the 3 ton unit).
- D. Remove the end ring from the load chain.

INSTALLING LOAD CHAIN 3/4 ton unit uses 1/4 in.(6.3mm) stock disc grade load

WARNING

IMPROPER INSTALLATION (REEVING) OF THE LOAD CHAIN CAN RESULT IN A DROPPED LOAD.

TO AVOID INJURY:

- VERIFY USE OF PROPER SIZE AND TYPE OF LOAD CHAIN FOR SPECIFIC RS2 LEVER HOIST.
- INSTALL LOAD CHAIN PROPERLY AS INDICATED BELOW

chain.

1-1/2 and 3 ton units use 5/16 in.(7.9mm) stock disc grade load chain.

- A. Feed a piece of soft wire thru one chain opening in the

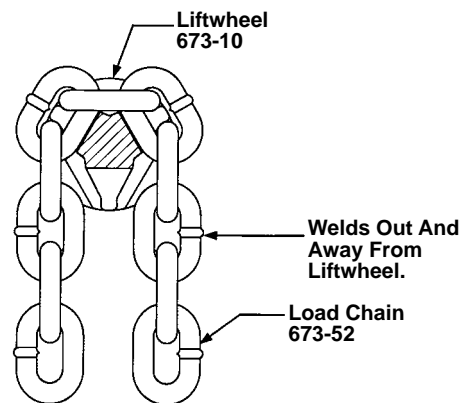

bottom of the frame, up and over the liftwheel, until it comes out the other opening.

- B. Attach the wire to the load chain to be installed.
- C. Make sure the unit is in free-chaining (see page 2).
- D. Position the chain so that the welds on the upstanding links will be up and away from the liftwheel and the first link entering the hoist is an upstanding link.
- E. Pull on the wire to pull the chain up and over the liftwheel.
- F. On 3/4 and 1-1/2 ton units, attach the lower hook block to the strand of chain that enters the "hook side" of the frame (printed on the nameplate). Tighten the hook block screw (673-51) firmly and then lock it in place by prick punching two spots 180° apart on edge of counterbore to drive metal into serrations on head of

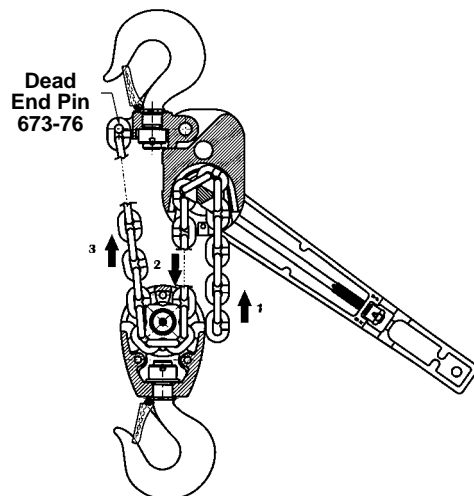

screw. If screw has been removed and replaced, always use new spots for locking.

On the 3 ton unit, hang it in the vertical position. Making sure there are no twists in the chain, feed the end of chain thru the hook block (673-71) and around lower sheave (637-70). Secure end of chain to hoist hanger using the dead end pin (673-76).

- G. Assemble the end ring (673-53) to the free (loose) end of chain by rotating the last link 1/4 turn and passing the ends of the ring thru the link as shown below. Hammer or squeeze the ends of the ring together to secure it to the chain.

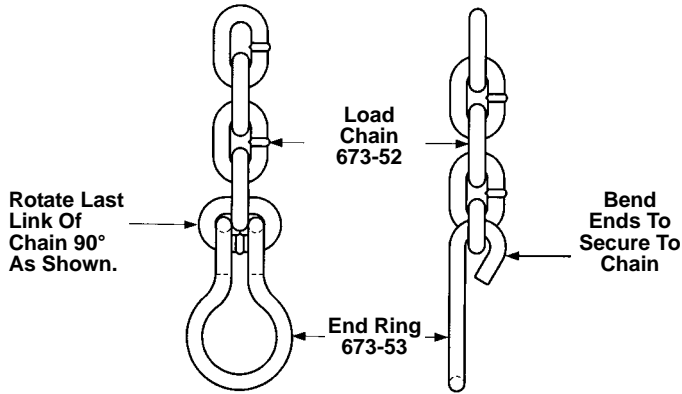

CUTTING CHAINS

Hoistaloy® load chain is hardened for wear resistance and is difficult to cut. However, the following methods are recommended when cutting a length of new chain from stock or cutting off a length of worn chain.

- (1) Use a grinder and nick the link on both sides, then secure the link in a vise and break off with a hammer.
- (2) Use a 7 inch(177.8mm) minimum diameter by 1/8 inch (3.175mm) thick abrasive wheel (of type recommended by wheel supplier) that will clear adjacent links.

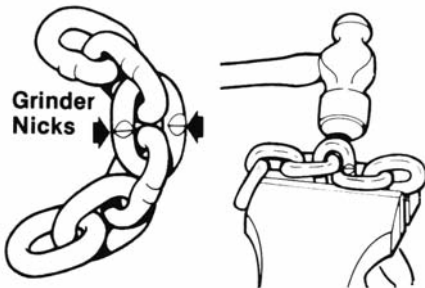

Cutting Chain by Nicking

- (3) Chain may also be cut using a bolt cutter with special jaws for cutting hardened chain (1 inch (25.4mm) long cutting edge).

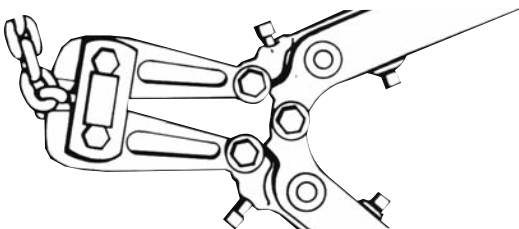

Cutting Chain with a Bolt Cutter



WARNING

CUTTING CHAIN CAN PRODUCE FLYING PARTICLES.

TO AVOID INJURY:

- WEAR EYE PROTECTION.
- PROVIDE A SHIELD, SUCH AS A HEAVY RAG, OVER THE CHAIN TO PREVENT FLYING PARTICLES.

TESTING

Prior to initial use, all altered or repaired hoists or hoists that have not been operated for the previous 12 months must be tested by the user for proper operation.

Test the unit first in the unloaded state and then with a light load of 50 pounds (23kg.) times the number of load supporting strands of load chain to be sure it operates properly and the brake holds the load when the lever is released; then test with a load of *125% of rated capacity. In addition, hoists in which load sustaining parts have been replaced shall be tested with *125% of rated capacity by or under the direction of an appointed person and a written report prepared for record purposes.

*If unit is equipped with a Load Limiter, it may refuse to lift the 125% overload. Should this occur, reduce the test load to rated capacity. Also, on such units, the function of the Load Limiter should be checked. To do this attach the lower hook to a load of 180% of rated capacity and operate the unit in the "up" direction. When attempting to lift this load, the lever should slip. If it does not, the Load Limiter must be replaced. After this test, operate the unit in the "down" direction to remove tension in the chain.

NOTE: For additional information on inspection and testing, refer to the current issue of ASME B30.21 "Manually Lever Operated Hoists" obtainable from ASME Order Department, 22 Law Drive, Box 2300, Fairfield, NJ 07007-2300, U.S.A.

RS2 LEVER HOIST PARTS LIST

KEY NO.	NO. REQ'D.	PART NAME	PART NUMBER		
			3/4 TON	1 1/2 TON	3 TON
673-1	1	Liftwheel Bearing	88645	88442	
673-2	1	Frame (includes 673-3 and (4) 673-4)	73304Y	73331Y	
673-3	1	Pinion Bearing, frame end	88642	88439	
673-4	4	Frame Pin	920720	73737	
673-5	1	Gear Cover (includes 673-6 and 673-7)	73305Y	73328Y	
673-6	1	Pinion Bearing, gear end	88644	88441	
673-7	1	Liftwheel bearing	88643	88439	
673-8	1	Brake Cover with seal	73306	73329	
673-9	1	Pinion	73345	73348	
673-10	1	Liftwheel	73308	73332	
673-11	1	Liftwheel Gear	73309	73325	
673-12	1	Friction Hub	73343	73350	
673-13	2	Friction Disc	73709	73742	
673-14	1	Ratchet Hub	73338	73323	
673-15	1	Chain Guide (Stripper)	73772	73745	
673-16	2	Upper hook block half	73701	73346	-
673-17	1	Lever Cover	73153	73154	
673-18	1	Cam	73708	73746	
673-19	2	Pawl	73700	73728	
673-20	1	Free-Chain Spring	73712	73743	
673-21	2	Pawl Spring	73713	73731	
673-22	2	Pawl Shaft	73315	73733	
673-23	1	Ratchet	73313	73326	
673-24	1	Ratchet Bushing	73710	73741	
673-25	1	Pinion Bushing	73711	73730	
673-26	1	Pinion Washer	73720	73729	
673-27	2	Lever Cover Screw	73718	73715	
673-28	6	Cover Screw	73715	73736	
673-29	1	Cam Screw	73717		
673-30	2	Upper Hook Block Screw	73716	73735	-
673-31	1	Stripper Pin Snap Ring	73722		
673-32	2	Pawl Snap Ring	73721	73738	
673-33	1	Suspension Bolt Snap Ring	73723	73734	
673-34	1	Stripper Pin	73318	73739	
*673-35	2	Hook with Latch (Latch type)	23030	40604	-
673-36	2	Latch Kit	595522	45662	45663
673-39	1	Lever Assembly (Includes 673-40, 673-41, 673-42, 673-43, 673-44, 673-45 and 673-46)	73600Y	73604Y	
673-40	1	Expansion Plug	940801		
673-41	1	Lever Plunger Spring	40735		
673-42	1	Lever Plunger Spring Pin	983766		
673-43	1	Trigger	40113Y		
673-44	1	Warning Label	40955		
673-45	1	Trigger Pin	983768		
673-46	1	Lever Plunger	73310	40462	
673-47	2	Cam Pin	73314	73744	
673-48	1	Suspension Bolt	73317	73770	
673-49	1	Hook Block, Drilled	40120	40142	-
673-50	1	Hook Block, Tapped	40121	40143	-

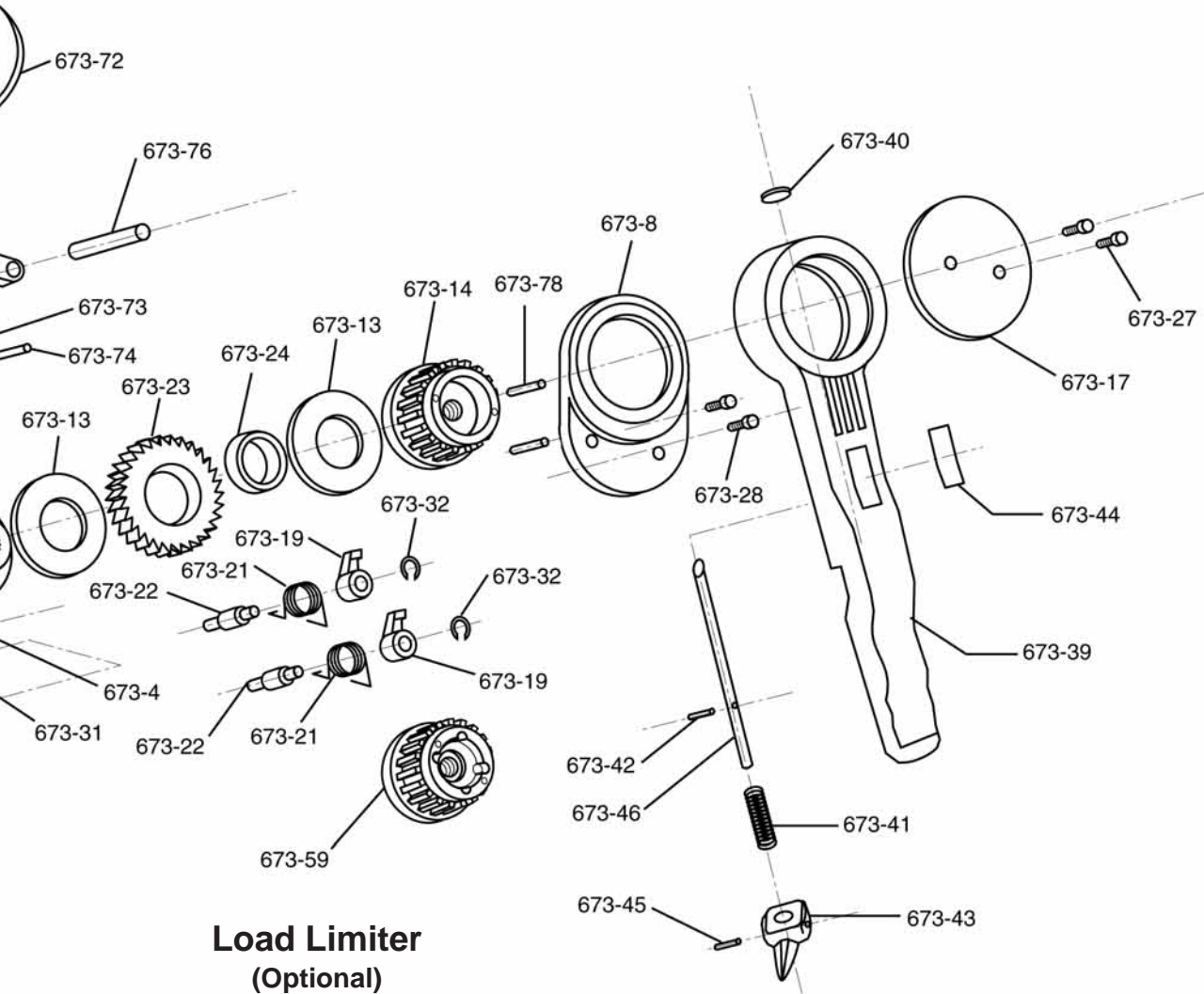

**Load Limiter
(Optional)**

Exploded View RS2 Lever Hoist

	WARNING
<p>USING "COMMERCIAL" OR OTHER MANUFACTURER'S PARTS TO REPAIR THE RS2 LEVER HOIST MAY CAUSE LOAD LOSS.</p>	
TO AVOID INJURY:	
<p>USE ONLY YALE SUPPLIED REPLACEMENT PARTS. PARTS MAY LOOK ALIKE BUT YALE PARTS ARE MADE OF SPECIFIC MATERIALS OR PROCESSED TO ACHIEVE SPECIFIC PROPERTIES.</p>	

ORDERING INFORMATION

The following information must accompany all correspondence or repair parts orders:

- 1) Capacity
- 2) Serial Number - this is stamped on the frame

For parts orders also specify:

- 1) Quantity desired
- 2) Key number of part
- 3) Part Name
- 4) Part number of the part

When ordering replacement parts, consideration should be given to the need to replace other items, (bushings, fasteners, etc.) and items that may be damaged or lost during disassembly or just unfit for future use because of deterioration from age or service.

Parts should be ordered from Yale Master Parts Depots conveniently located throughout the United States. Refer to the back of front cover of this manual to locate the Parts Depot nearest you.

673-66
3-71

Block Hook

KEY NO.	NO. REQ'D.	PART NAME	PART NUMBER		
			3/4 TON	1 1/2 TON	3 TON
673-51	1	Hook Block Screw	40854	40855	-
673-52	-	Load Chain (Specify Length Req'd.)	85839	85847	
673-53	1	End Ring	40471		
673-54	1	Capacity Label	73759	73751	73752
673-55	1	I.D. Label	73901	73903	
673-56	1	Warning Tag	73905		
673-57	1	Patent Label (no longer available order 673-55)	-		
673-58	1	Load Limiter Label (Only for units with Load Limiter)	73763		
673-59	1	Load Limiter (Optional)	7310 P	7311 P	7311 P
673-60	1	Cam Washer	73316		
673-61	1	Anchor Sling	7309 P	7312 P	-
*673-62	1	Lower Hook with latch (Latch type)	-	-	40606
673-63	1	Lower Hook Washer	-	-	50454
673-64	1	Lower Hook Nut	-	-	40382
673-65	1	Lower Hook Nut Pin	-	-	982335
673-66	3	Lower Hook Block Screw	-	-	940812
673-67	3	Lower Hook Block Screw L.W.	-	-	940830
673-68	3	Lower Hook Block Screw Nut	-	-	945820
673-69	1	Reeving Caution Plate	-	-	45757
673-70	1	Lower Sheave	-	-	40166
673-71	2	Lower Hook Block	-	-	40689
*673-72	1	Upper Hook with latch (latch type)	-	-	40606
673-73	1	Upper Hook Nut	-	-	40382
673-74	1	Upper Hook Nut Pin	-	-	982335
673-75	1	Hoist Hanger	-	-	73324
673-76	1	Dead End Pin	-	-	40851
**673-77	1	Upper hook block assembly (includes 673-16,673-30 and 673-35)	73606	73607	-
673-78	2	Lock Pin	73340	73342	

* If latchlok hook is required, part numbers are: 3/4 ton upper and lower hooks - 1001, 1 1/2 ton upper and lower hooks - 1002
3 ton lower hook - 1004, 3 ton upper hook - 1010

** If latchlok hook is required, contact Yale.

PART NUMBERS FOR PACKAGED LUBRICANTS USED IN THE RS2 LEVER HOISTS (REFER TO PAGE 6 FOR LUBRICATION INSTRUCTIONS)		
LUBRICANT USAGE	TYPE OF LUBRICANT	PART NUMBERS AND PACKAGED QUANTITIES OF LUBRICANTS
3 TON LOWER SHEAVE BEARING JOURNALS AND SEAT FOR HOOK KNOB (3/4 AND 1-1/2 TON)	GREASE-GRAPHITE MIXTURE	40626 (1 LB., .46 Kg. CAN)
TIP OF LEVER PLUNGER AND THREADED END OF PINION SHAFT	DRY-LUBE OIL-	40628 (1 PT., .5L CAN) GRAPHITE MIXTURE
INSIDE OF LEVER HEAD	GREASE	40630 (1 LB., .46 Kg. CAN)
GEARS, LIFTWHEEL SPLINE, NEEDLE BEARINGS, PINION BUSHING, CAM AND LOCK PINS, CAM SLOTS, AND I.D. OF CAM	GREASE	28610 (1 LB., .46 Kg. CAN) 28632 (4 LB., 1.8 Kg. CAN)
THREADS OF PINION	SPRAY DRY LUBRICANT	46698 (16 OZ. CAN)
LOAD CHAIN	OIL	28608 (1 PT., .5L CAN)

When ordering lubricants, specify the type of lubricant, part number and packaged quantity required.

Touch-up paint for the RS2:

*(1) case (12-12 oz. Aerosol Cans) of Yellow Touch-up Paint Part Number 40215.

*Touch-up paints are only available in case quantities.

NOTE: When painting the hoists, also order warning labels and capacity labels that may be coating during painting.

Note: When ordering parts, always furnish rated load and serial number of hoist on which the parts are to be used.
For the location of the nearest Yale Authorized Hoist Parts Depot, see inside front cover.

LIMITATION OF WARRANTIES, REMEDIES AND DAMAGES

THE WARRANTY STATED BELOW IS GIVEN IN PLACE OF ALL OTHER WARRANTIES, EXPRESS OR IMPLIED, OF MERCHANTABILITY, FITNESS FOR A PARTICULAR PURPOSE, OR OTHERWISE, NO PROMISE OR AFFIRMATION OF FACT MADE BY ANY AGENT OR REPRESENTATIVE OF SELLER SHALL CONSTITUTE A WARRANTY BY SELLER OR GIVE RISE TO ANY LIABILITY OR OBLIGATION.

Seller warrants that on the date of delivery to carrier the goods are free from defects in workmanship and materials.

SELLER'S SOLE OBLIGATION IN THE EVENT OF BREACH OF WARRANTY OR CONTRACT OR FOR NEGLIGENCE OR OTHERWISE WITH RESPECT TO GOODS SOLD SHALL BE EXCLUSIVELY LIMITED TO REPAIR OR REPLACEMENT, F.O.B. SELLER'S POINT OF SHIPMENT, OF ANY PARTS WHICH SELLER DETERMINES TO HAVE BEEN DEFECTIVE or if Seller determines that such repair or replacement is not feasible, to a refund of the purchase price upon return of the goods to Seller.

Any action against Seller for breach of warranty, negligence or otherwise, must be commenced within one year after such cause of action occurs.

NO CLAIM AGAINST SELLER FOR ANY DEFECT IN THE GOODS SHALL BE VALID OR ENFORCEABLE UNLESS BUYER'S WRITTEN NOTICE THEREOF IS RECEIVED BY SELLER WITHIN ONE YEAR FROM THE DATE OF SHIPMENT. Seller shall not be liable for any damage, injury or loss arising out of the use of the goods if, prior to such damage, injury or loss, such goods are (1) damaged or misused following Seller's delivery to carrier; (2) not maintained, inspected, or used in compliance with applicable law and Seller's written instructions

and recommendations; or (3) installed, repaired, altered or modified without compliance with such law, instructions or recommendations.

UNDER NO CIRCUMSTANCES SHALL SELLER BE LIABLE FOR INCIDENTAL OR CONSEQUENTIAL DAMAGES AS THOSE TERMS ARE DEFINED IN SECTION 2-715 OF THE UNIFORM COMMERCIAL CODE.

INDEMNIFICATION AND SAFE OPERATION

Buyer shall comply with and require its employees to comply with directions set forth in instructions and manuals furnished by Seller and shall use and require its employees to follow such instructions and manuals and to use reasonable care in the use and maintenance of the goods. Buyer shall not remove or permit anyone to remove any warning or instruction signs on the goods. In the event of personal injury or damage to property or business arising from the use of the goods, Buyer shall within 48 hours thereafter give Seller written notice of such injury or damage. Buyer shall cooperate with Seller in investigating any such injury or damage and in the defense of any claims arising therefrom.

If Buyer fails to comply with this section or if any injury or damage is caused, in whole or in part, by Buyer's failure to comply with applicable federal or state safety requirements, Buyer shall indemnify and hold Seller harmless against any claims, loss or expense for injury or damage arising from the use of the goods.

 WARNING
ALTERATIONS OR MODIFICATIONS OF EQUIPMENT AND USE OF NON-FACTORY REPAIR PARTS CAN LEAD TO DANGEROUS OPERATION AND INJURY.
TO AVOID INJURY:
<ul style="list-style-type: none">• DO NOT ALTER OR MODIFY EQUIPMENT• DO USE ONLY FACTORY PROVIDED REPLACEMENT PARTS

For more information contact:
American Crane & Equipment Corp.
Authorized Distributor
Tel: 877-503-2972
Fax: 484-945-0430
sales@americancrane.com
www.americancrane.com

Yale[®]
HOISTS

414 WEST BROADWAY AVENUE
MUSKEGON, MICHIGAN 49443
1-866-805-2962 • Fax: 1-800-742-